

# **MORETON / CROSSWAYS / WOODSFORD**

## Traffic Impact Assessment 2016

Matthew Piles  
Service Director - Economy

November 2016

**DORSET COUNTY COUNCIL,  
ENVIRONMENT AND THE ECONOMY**

**DOCUMENT STATUS SHEET**

Document Title	<b>Moreton / Crossways / Woodsford – Traffic Impact Assessment 2016</b>
Author	<b>Phil Channer</b>
Checked	<b>Alice Jones</b>
Authorised for Issue	<b>Mike Moore</b>
Document Reference	<b>TM9999_J077_01_Rev0.docx</b>
Date of original issue	<b>4 November 2016</b>
Registered Holder	<b>Phil Channer</b>

**RECIPIENTS**

<b>Date</b>	<b>Name/Organisation</b>
<b>04-11-2016</b>	<b>Trevor Badley – Dorset County Council</b>
<b>04-11-2016</b>	<b>Trevor Warrick – West Dorset District Council</b>

**REVISIONS**

Details of revisions should be recorded manually on this form, which must be kept at the front of the document to which it refers

<b>Rev</b>	<b>Description</b>	<b>Date</b>
<b>A</b>		
<b>B</b>		
<b>C</b>		
<b>D</b>		
<b>E</b>		

**CONTENTS**

<b>1.0</b>	<b>INTRODUCTION</b>	<b>5</b>
	Background	5
<b>2.0</b>	<b>EXISTING TRAFFIC LEVELS</b>	<b>6</b>
	Data Collection	6
	Existing Data	7
	Historic Data	9
	Use of Data	10
<b>3.0</b>	<b>SATURN TRAFFIC MODEL</b>	<b>11</b>
	Model Creation	11
	Link Count Calibration and Validation Summary	12
<b>4.0</b>	<b>FORECASTING</b>	<b>13</b>
	Background Growth	13
	Local Development Growth	13
	Quarry Traffic	16
<b>5.0</b>	<b>MODEL RESULTS</b>	<b>18</b>
	Overall Network Statistics	18
	Overall Difference Plots	19
	Quarry Traffic Difference Plots	25
<b>6.0</b>	<b>CONCLUSIONS</b>	<b>38</b>

## **EXECUTIVE (NON-TECHNICAL) SUMMARY**

This Traffic Impact Assessment of proposed built development and minerals development in the Moreton / Crossways / Woodsford area has been undertaken by Dorset County Council's Transportation Modelling Team

Existing traffic levels were been established by way of manual and automatic traffic counts carried out at strategic locations. Traffic flows on the B3390 north of Crossways and A352 west of Owermoigne have reduced over the last ten years whereas traffic flows on the A35 Puddletown bypass have increased. This is most likely due to a combination of the recession and the opening of the Weymouth Relief Road.

The data was used to calibrate an inter-peak traffic model of the study area which was cordoned (extracted) from an existing older (outdated) larger model. The new model adequately reflects current (2016) average traffic flows.

A core future scenario was created for 2031 based on information from the Department for Transport's National Trip End Model, the industry standard 'TRICS' trip rate database and work carried out in developers Transport Assessments. This scenario contains 21.1% more trips than the base 2016 year and excludes the proposed local development growth in the study area.

Five additional scenarios were modelled to test different proposals for future housing growth. Scenarios ranged from 640 dwellings to a worst case of 2,800 dwellings around Crossways and Moreton. All scenarios included trips attributed to the 'Silverlake' development. The worst case scenario contained 44.4% more trips than the base 2016 year.

Future quarry traffic was calculated based on information supplied in the brief. Total quarry related traffic is predicted to reduce as in future only two quarries will be working simultaneously rather than the current three. Identical future year quarry traffic was included in each of the forecast scenarios.

All inter-peak forecast models performed well and showed no signs of excessive queuing or deterioration of vehicle speeds (increasing congestion) in any scenario

In the worst case scenario (2800 dwellings), significant increases in traffic were noted on the B3390 south of Crossways and the C33 West Stafford Bypass. However, the highest predicted future flows on these roads are around 550 Passenger Car Units (PCUs) per hour which should be comfortably accommodated in terms of capacity.

All scenarios exhibited increases in traffic which could cause some additional queuing at the Moreton and Woodsford No. 38 Level Crossings.

The proposed developments in the worst case scenario has some effect on the key junctions however, the modelled volume over capacity figures show each junction should cope with the predicted inter-peak traffic.

## 1.0 INTRODUCTION

### Background

- 1.1 Dorset County Council's Transportation Modelling Team were commissioned on 26 May 2016 by Trevor Badley of Minerals and Waste Planning Policy to undertake a Traffic Impact Assessment of proposed built development and minerals development in the area.
- 1.2 The work undertaken is based on a scoping note dated 21 April 2016 and consists of four elements:
- Establish existing traffic levels
  - Identify expected increases in traffic levels
  - Identify routes of predicted traffic
  - Quantify impacts of predicted traffic
- 1.3 Traffic data collected on 24 May 2016 at Warmwell Quarry, Woodsford Quarry and Moreton Pit, shows that 67% of heavy goods vehicles associated with quarries use the highway network in the inter peak period between 10:00 and 16:00. Therefore, the inter-peak period is the focus for this study.
- 1.4 The study area is shown in **Figure 1.1**.

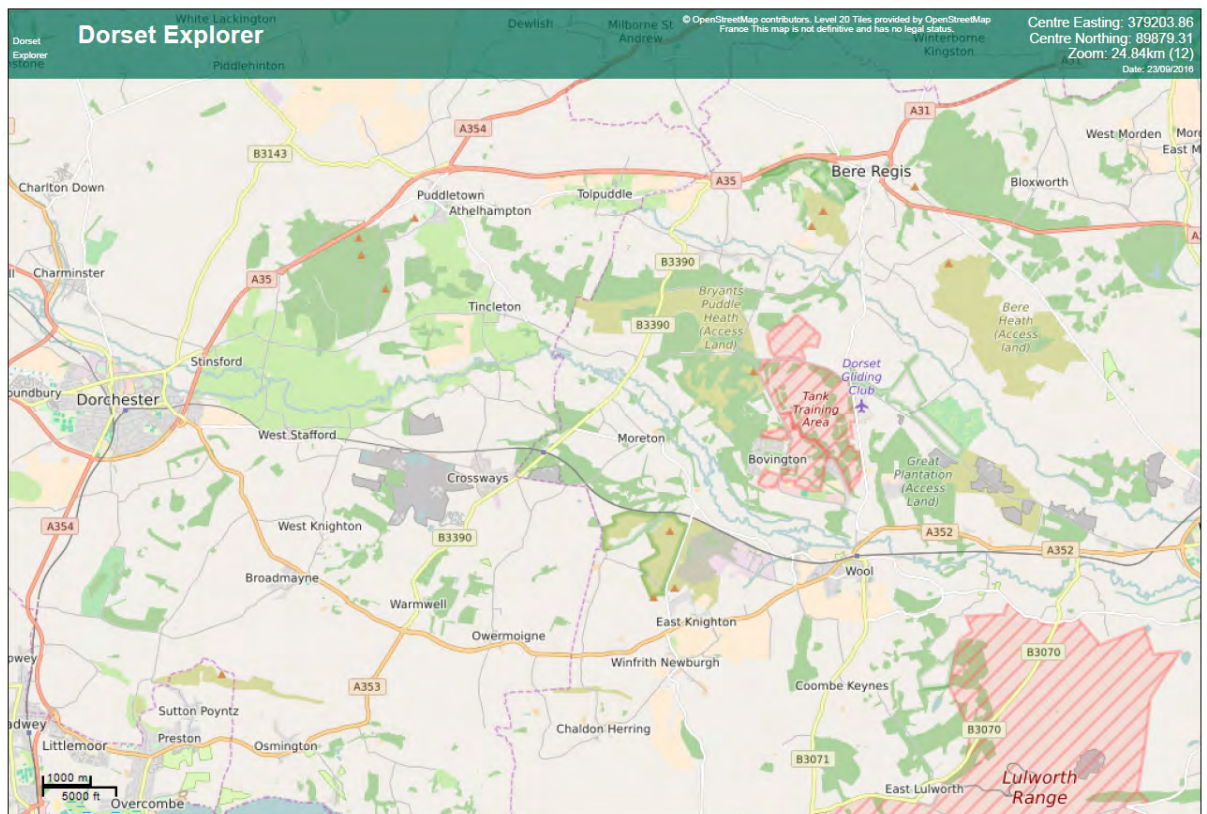

**Figure 1.1 – Study Area**

**2.0 EXISTING TRAFFIC LEVELS**

**Data Collection**

2.1 Traffic count data was collected at a number of locations by way of Automatic Traffic Counts (ATC) and Manual Turning Counts (MTC). The ATCs are listed in **Table 2.1** and shown in **Figure 2.1**. The MTC are listed in **Table 2.2** and shown in **Figure 2.2**.

ID	Location	Start Date	End Date	Easting	Northing
10	A352 Owermoigne	23/05/2016	29/05/2016	376567	85003
317	A352 Came	18/04/2016	24/04/2016	371192	88810
355	B3390 North of Level Crossing	17/05/2016	23/05/2016	377550	88715
1450	West of Crossways	17/05/2016	23/05/2016	375882	88905
1451	B3390 Warmwell Rd, Crossways	17/05/2016	23/05/2016	375510	86832
1634	C33 East of West Stafford	17/05/2016	23/05/2016	374061	89625
2054	B3390 Warmwell Rd, Crossways	17/05/2016	23/05/2016	376801	88220
2137	B3390 Warmwell Rd, Crossways	18/05/2016	24/05/2016	375292	85875
2965	A352 South of Whitcombe	18/04/2016	24/04/2016	272023	87354
3018	D21322 West Link Road	17/05/2016	23/05/2016	376558	88279

**Table 2.1 – Automatic Traffic Counts**

ID	Location	Date	Easting	Northing
50154	B3390/C80 Waddock Cross	17/05/2016	379946	91073
50155	B3390/C33 Hurst Heath Cross	24/05/2016	378555	89584
50156	Warmwell Road / Redbridge Road / Dick of the Banks Road / Moreton Road	19/05/2016	377384	88580
50157	Warmwell Road / West Link Road	19/05/2016	376662	88125
50158	Dick Of The Banks Road / West Link Road / Highgate Lane	19/05/2016	376503	88704
50159	Warmwell Quarry (Highgate Lane)	24/05/2016	375864	88912
50160	Woodsford Quarry (Highgate Lane)	24/05/2016	375133	89205
50161	Moreton Pit (Redbridge Road)	24/05/2016	378151	88507
50162	Warmwell Roundabout	14/06/2016	347981	85406
50167	Highgate Lane / Lewell Lane	19/05/2016	374128	89622

**Table 2.2 – Manual Traffic Counts**

## Existing Data

- 2.2 Further existing automatic traffic count data collected by Dorset County Council, Highways England and from two Transport Assessments was also used. Existing ATC data is listed in **Table 2.3** and shown in **Figure 2.1**. Existing MTC data is listed in **Table 2.4** and shown in **Figure 2.2**.

ID	Location	Start Date	End Date	Easting	Northing
1394	C80 East of B3390, Waddock Cross	13/05/2010	19/05/2010	380759	91139
1395	C33 West Stafford Bypass	17/03/2014	30/03/2014	371331	89654
1636	Higher Woodsford	07/03/2013	13/03/2013	376610	89433
2004	A35 Yellowham Hill	07/03/2016	20/03/2016	372552	92964
2005	A35 Rogers Hill Farm	01/05/2016	31/05/2016	382910	95105
2240	Dick 'O' The Banks Road	01/06/2015	07/06/2015	377268	88624
2464	A35 East of A354 Northbrook Interchange	01/05/2016	31/05/2016	377146	94954
2596	A352 Broadmayne	29/11/2014	05/12/2014	373255	86425
2866	B3390 Warmwell Road, Crossways	01/10/2014	07/10/2014	377203	88471

**Table 2.3 – Existing Automatic Traffic Counts**

ID	Location	Date	Easting	Northing
5138-0411	Stinsford Roundabout	04/10/2011	370869	91228
5138-0311	A35 / A352 Junction	04/10/2011	370260	89738
5138-0211	Max Gate Roundabout	04/10/2011	370458	89795
Jct 3*	C33 / A352	12/05/2015	370733	89627
Jct 8AC*	B3390 / A35 Eastbound Slip	12/05/2015	381452	94825
Jct 8B*	B3390 / A35 Westbound Slip	12/05/2015	381134	94741

\* - Traffic Count AM and PM periods only (no Inter peak data)

**Table 2.4 – Existing Manual Traffic Counts**





Note – Triangles = New Data Collection, Stars = existing data

Figure 2.1 – Location of Automatic Traffic Counts

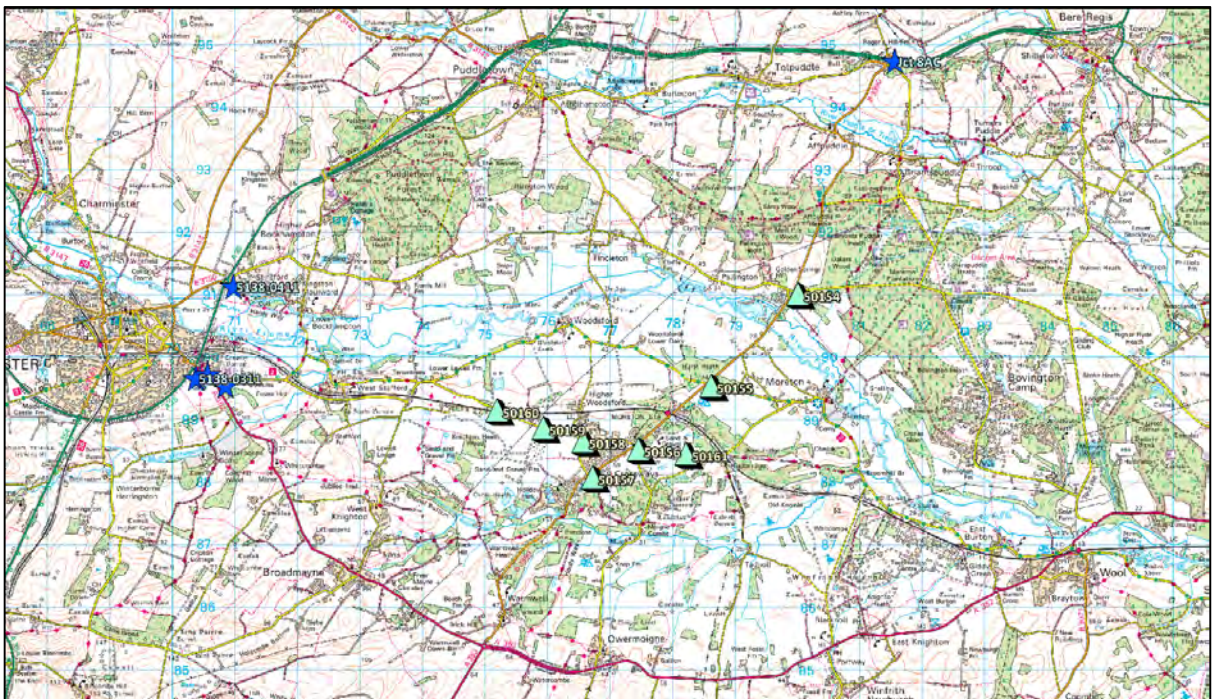

Note – Triangles = New Data Collection, Stars = existing data

Figure 2.2 – Location of Manual Traffic Counts



**Historic Data**

2.3 Three traffic count sites in the study area are monitored regularly from which Annual Average Daily Traffic (AADT) figures are produced. Historic traffic flows (2005 to 2014) are shown in **Figure 2.3**, **Figure 2.4** and **Figure 2.5**.

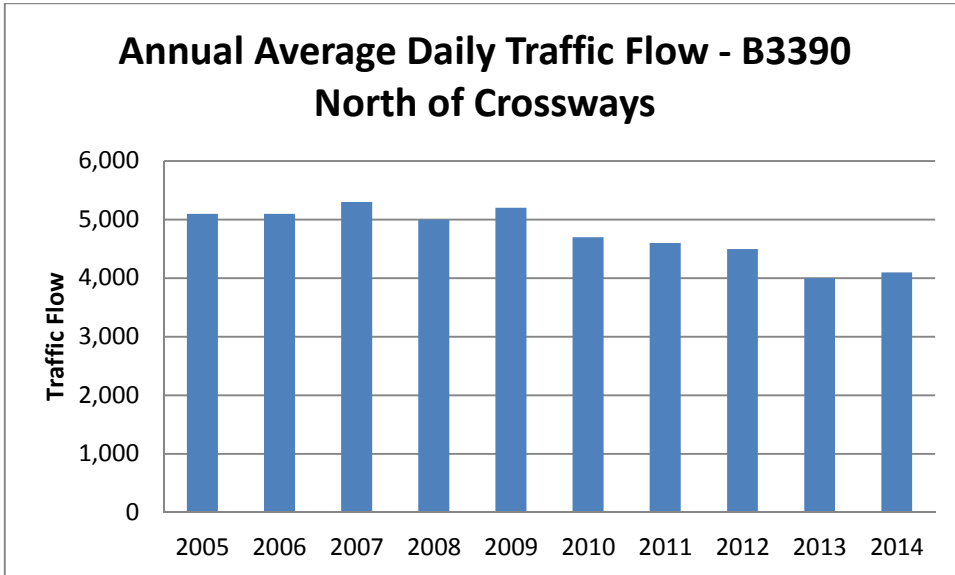

**Figure 2.3 – B3390 North of Crossways AADT Flows 2005-2014**

2.4 Traffic flows on the B3390 north of Crossways have fallen since 2009. This is due to a combination of the recession and the opening of the Weymouth Relief Road. The AADT has reduced by around 20 percent from a peak of 5,300 vehicles per day in 2007 to 4,100 vehicles per day in 2014.

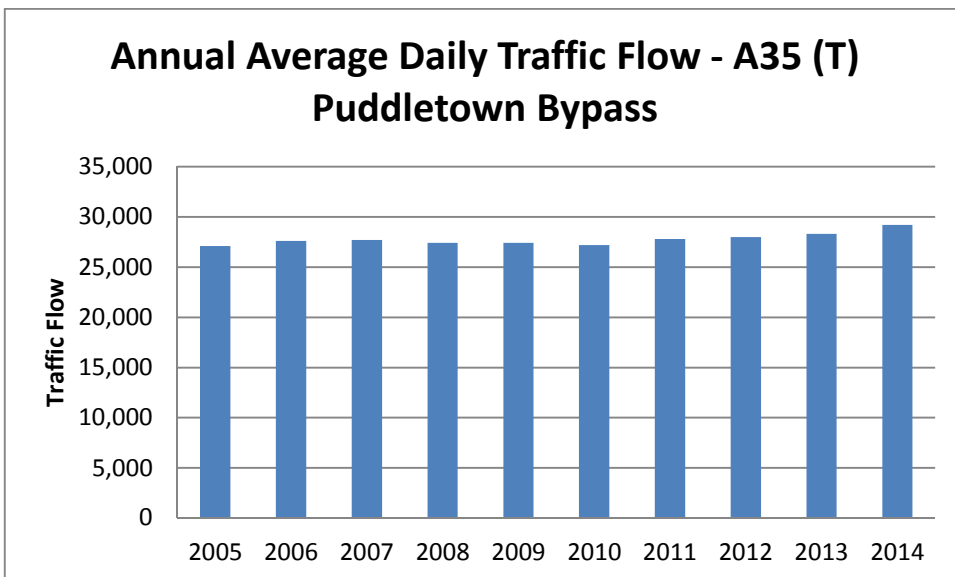

**Figure 2.4 – A35 (T) Puddletown Bypass AADT Flows 2005-2014**

- 2.5 Traffic flows on the A35 (T) west of Puddletown have gradually increased since 2005. This is partially due to the opening of the Weymouth Relief Road which has made the route more attractive for vehicles travelling to and from Weymouth from the east. The AADT flow has increased by around 8 percent from 27,100 vehicles per day in 2005 to 29,200 vehicles per day in 2014.

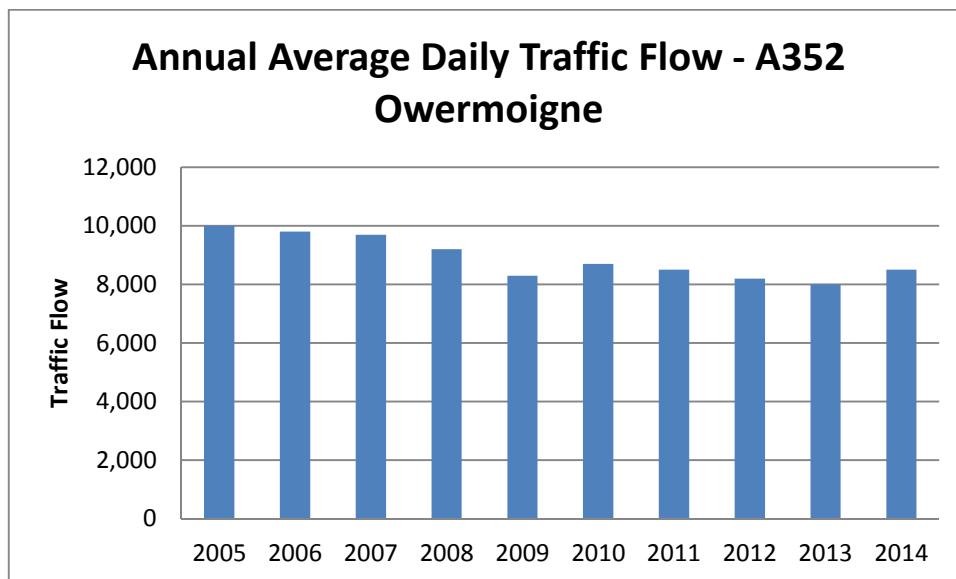

**Figure 2.5 – A352 Owermoigne AADT Flows 2005-2014**

- 2.6 Traffic flows on the A352 west of Owermoigne have gradually fallen since 2005. This is due to a combination of the recession and the opening of the Weymouth Relief Road. The AADT has reduced by 15 percent from a peak of 10,000 vehicles per day in 2005 to 8,500 vehicles per day in 2014.

**Use of Data**

- 2.7 The data was used in the calibration of an inter-peak SATURN traffic model (discussed in Chapter 3). The model is based on an existing model completed in 1999 but has been updated to include alterations to the highway network and current traffic flows.
- 2.8 The model represents current (2016) conditions for a neutral time of year (spring) for the inter-peak period (average of 10:00 to 16:00).

### 3.0 SATURN TRAFFIC MODEL

#### Model Creation

3.1 The network for this study was extracted / cut-from (Cordoned) from a larger existing SATURN model of the Crossways area created in 1999. The area extracted is shown in **Figure 3.1**. The network was audited and altered where necessary to reflect current conditions. Changes included altering speed limits and junction layouts.

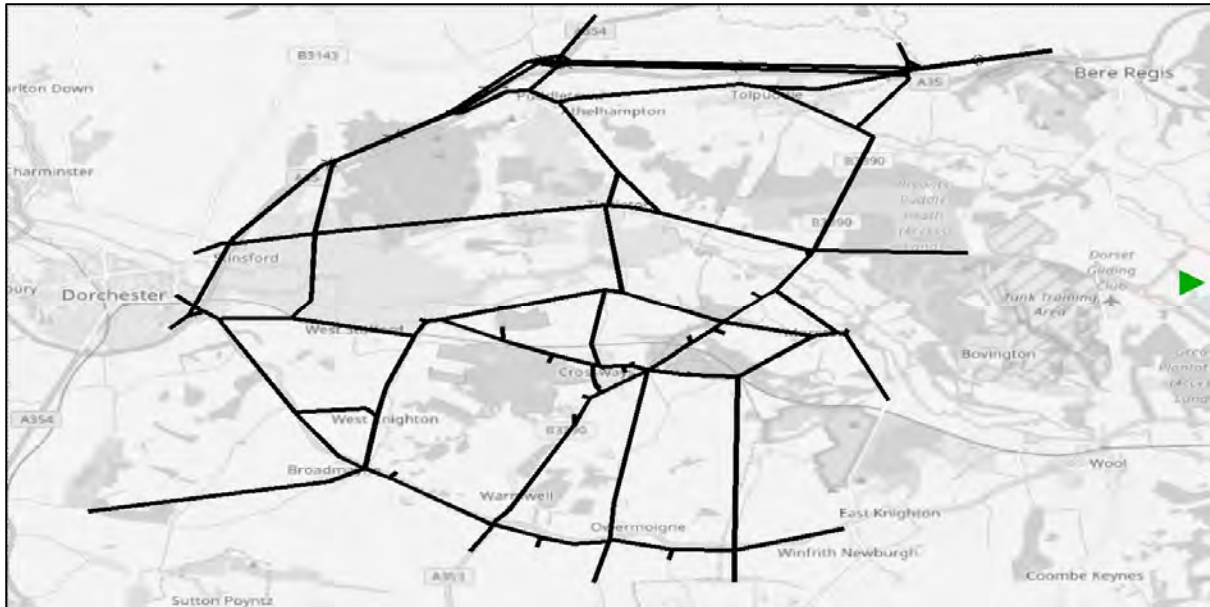

**FIGURE 3.1 – SATURN Model Network**

3.2 Traffic for the model is contained in 70-zone matrices (Modelled traffic enters and exits the network at 70 locations). A list of the zones and their descriptions are contained in **Appendix A**. Each matrix contains the following four levels:

- Level 1 – Cars
- Level 2 – Light Goods Vehicles
- Level 3 – Heavy Goods Vehicles
- Level 4 – Quarry related Heavy Goods Vehicles

3.3 Buses are represented separately as fixed route trips

3.4 The model matrices were altered during the calibration process to reflect the traffic observed in the May / June 2016 traffic counts.

3.5 Calibration results (link counts) are contained in **Appendix B** and validation results (independent turning counts) are contained in **Appendix C**. To be considered a robust model, the calibration and validation results should meet the criteria set out in the Design Manual for Roads and Bridges (DMRB) Volume 12.

3.6 Table 3.1 summarises the DMRB Criteria for traffic flow Calibration / Validation. Both the GEH statistic and the absolute or relative flow difference for the complete model have been assessed.

	<b>Criteria and Measurements</b>	
	<b>Assigned Hourly Flows</b>	<b>Acceptable Guidelines</b>
<b>1</b>	Individual flows within 100vph (flows<700vph)	85% of all cases
<b>2</b>	Individual flows within 15% (flows 700 -2700vph	85% of all cases
<b>3</b>	Individual flows within 400 vph for flows >2700vph	85% of all cases
<b>4</b>	Total Screenline flows within 5%	All (or nearly all) screenlines
<b>5</b>	GEH Statistics: individual flows GEH<5	85% of all cases
<b>6</b>	GEH Statistics: screenline flows GEH<4	All (or nearly all) screenlines

**Table 3.1 – DMRB Criteria**

3.7 The GEH statistic is used in the validation of the model to compare the difference between an observed flow and a modelled flow, acceptability guidelines contained within the DMRB state more than 85% of cases should have a GEH value of less than 5.

**Link Count Calibration and Validation Summary**

3.8 **Table 3.2** shows the overall calibration and validation results for the link counts based on the data in **Appendix B** and **Appendix C**.

<b>Inter Peak (average of 1000-1600)</b>	<b>Total counts</b>	<b>Total With GEH &lt; 5</b>	<b>Percentage</b>	<b>Within guidelines?</b>
<b>Calibration</b>	34	34	100%	YES
<b>Validation</b>	94	80	85.1%	YES

**Table 3.2 – Link Calibration/ Validation Summary Table**

3.9 It can be seen from Table 3.2 that percentage of results for both calibration and validation meet the DMRB guidelines for traffic counts and the model validates well.

## 4.0 FORECASTING

### Background Growth

- 4.1 Forecasting has been carried out in-line with guidance contained in TAG UNIT M4 – Forecasting and Uncertainty (November 2014).
- 4.2 The base year is 2016 and the forecast year 2031.
- 4.3 Future car trips have been calculated based on data from the ‘**TEMPRO v.7**’ dataset. Future goods vehicles trips have been based on NTM data from the DfT document ‘**Road Traffic Forecasts 2015**’.
- 4.4 Growth factors used are contained in **Appendix D**. These have been applied to the 2016 base year matrices.
- 4.5 This background growth has been modelled as the 2031 Core Forecast Scenario (SC0). This scenario contains 21.1% more traffic than the base year and excludes the proposed local development growth in the Crossways area.

### Local Development Growth

- 4.6 Future local development growth levels have been mainly based on two recent Transport Assessments;
- Land South of Warmwell Road Crossways, C&G Properties, January 2016
  - Silverlake Warmwell, Entran Ltd, July 2013
- 4.7 Chapter 6 of the ‘Land South of Warmwell Road’ report contains information on Trip Generation and Distribution. Future generation of residential trips has been calculated using the TRICS (Trip Rate Information Computer System) database.
- 4.8 The proposed numbers of future dwellings was set out in the brief for the following five scenarios:

#### Scenario 1 (SC1)

The ‘do nothing’ scenario – comprises of approximately 640 dwellings (and 8 commercial units) plus further infilling / intensification within the existing settlement boundaries of Moreton and Crossways. Total: approximately 640 dwellings

#### Scenario 2 (SC2)

Low growth scenario – In addition to the 640 residential units identified at Crossways in Scenario 1, Scenario 2 would test the impacts if around 500 dwellings were to be provided at Moreton through the Purbeck Local Plan review. Total: approximately 1140 dwellings.



**Scenario 3 (SC3)**

Medium growth scenario – In addition to the 640 identified in Scenario 1, Scenario 3 will test a slightly higher level of development at Moreton (650 dwellings) alongside an additional 500 dwellings at Crossways. Total: approximately 1790 dwellings.

**Scenario 4 (SC4)**

High growth scenario – In addition to the 640 identified in Scenario 1, the 500 suggested at Moreton in Scenario 2 and the 500 suggested at Crossways through Scenario 3, an additional 400 (i.e. the maximum potential allocation) could be allocated at Moreton. Total: approximately 2040 dwellings.

**Scenario 5 (SC5)**

Maximum growth scenario – In addition to the 640 identified in Scenario 1, the maximum identified potential at Moreton (900 dwellings) and the maximum identified potential at Crossways (1260 dwellings) would be allocated. Total: approximately 2800 dwellings.

- 4.9 All scenarios include trips attributed to the ‘Silverlake’ development.
- 4.10 Trips rates applied to the number of developments have been calculated using TRICS (a widely used web-based database). These are the predicted number of car trips for each household by time period. The trip rates have not been reduced to take account of multi modal trip methods or travel plans thus represent a worst case scenario. The calculated trip rates are contained in **Table 4.1**. Full TRICS output is contained in **Appendix E**.

Development	Zone	Type	Percent	AM Arr.	AM Dep.	IP Arr.	IP Dep.	PM Arr.	PM Dep.
Crossways	10	Privately Owned	0.65	0.130	0.430	0.189	0.178	0.519	0.338
Crossways	10	Affordable	0.35	0.099	0.210	0.112	0.108	0.193	0.121
Crossways	10			<b>0.229</b>	<b>0.640</b>	<b>0.301</b>	<b>0.286</b>	<b>0.712</b>	<b>0.459</b>
Moreton	45	Privately Owned	0.65	0.130	0.430	0.189	0.178	0.519	0.338
Moreton	45	Affordable	0.35	0.099	0.210	0.112	0.108	0.193	0.121
Moreton	45			<b>0.229</b>	<b>0.640</b>	<b>0.301</b>	<b>0.286</b>	<b>0.712</b>	<b>0.459</b>

**Table 4.1 – Calculated Trip Rates**

- 4.11 The additional trips attributed to the Silverlake development have been taken directly from the report ‘Silverlake Warmwell, Entran Ltd, July 2013’. These are based on (worst case) Friday trips.
- 4.12 Total additional development trips for each scenario are contained in **Tables 4.2 to 4.6**.

Scenario 1	Zone	AM Arrive	AM Depart	IP Arrive	IP Depart	PM Arrive	PM Depart
Crossways South of B3390	10	59	177	81	77	203	131
Moreton	45	17	49	23	21	56	37
Silverlake	17	39	33	39	33	39	33
<b>TOTAL</b>		<b>115</b>	<b>259</b>	<b>143</b>	<b>131</b>	<b>298</b>	<b>201</b>

**Table 4.2 – Scenario 1 Development Trips**

Scenario 2	Zone	AM Arrive	AM Depart	IP Arrive	IP Depart	PM Arrive	PM Depart
Crossways South of B3390	10	59	177	81	77	203	131
Moreton	45	17	49	23	21	56	37
Moreton 500	45	59	177	81	77	203	131
Silverlake	17	39	33	39	33	39	33
<b>TOTAL</b>		<b>174</b>	<b>436</b>	<b>224</b>	<b>208</b>	<b>501</b>	<b>332</b>

**Table 4.3 – Scenario 2 Development Trips**

Scenario 3	Zone	AM Arrive	AM Depart	IP Arrive	IP Depart	PM Arrive	PM Depart
Crossways South of B3390	10	59	177	81	77	203	131
Moreton	45	17	49	23	21	56	37
Crossways 500	10	59	177	81	77	203	131
Moreton 650	45	78	230	106	100	263	171
Silverlake	17	39	33	39	33	39	33
<b>TOTAL</b>		<b>252</b>	<b>666</b>	<b>330</b>	<b>308</b>	<b>764</b>	<b>503</b>

**Table 4.4 – Scenario 3 Development Trips**

Scenario 4	Zone	AM Arrive	AM Depart	IP Arrive	IP Depart	PM Arrive	PM Depart
Crossways South of B3390	10	59	177	81	77	203	131
Moreton	45	17	49	23	21	56	37
Crossways 500	10	59	177	81	77	203	131
Moreton 900	45	107	318	145	138	365	236
Silverlake	17	39	33	39	33	39	33
<b>TOTAL</b>		<b>281</b>	<b>754</b>	<b>369</b>	<b>346</b>	<b>866</b>	<b>568</b>

**Table 4.5 – Scenario 4 Development Trips**

Scenario 5	Zone	AM Arrive	AM Depart	IP Arrive	IP Depart	PM Arrive	PM Depart
Crossways South of B3390	10	59	177	81	77	203	131
Moreton	45	17	49	23	21	56	37
Crossways 1260	10	150	445	205	194	510	330
Moreton 900	45	107	318	145	138	365	236
Silverlake	17	39	33	39	33	39	33
<b>TOTAL</b>		<b>372</b>	<b>1022</b>	<b>493</b>	<b>463</b>	<b>1173</b>	<b>767</b>

**Table 4.6 – Scenario 5 Development Trips**

**Quarry Traffic**

4.13 Additional trips attributed to the future quarries have been taken from the brief.

- Woodsford Extension – No change (60 in and 60 out per day)
- Station Road Moreton – (40 in and 40 out per day)
- Hurst Farm Moreton – (40 in and 40 out per day)

4.14 Locations of the quarries are shown in Figure 4.1.

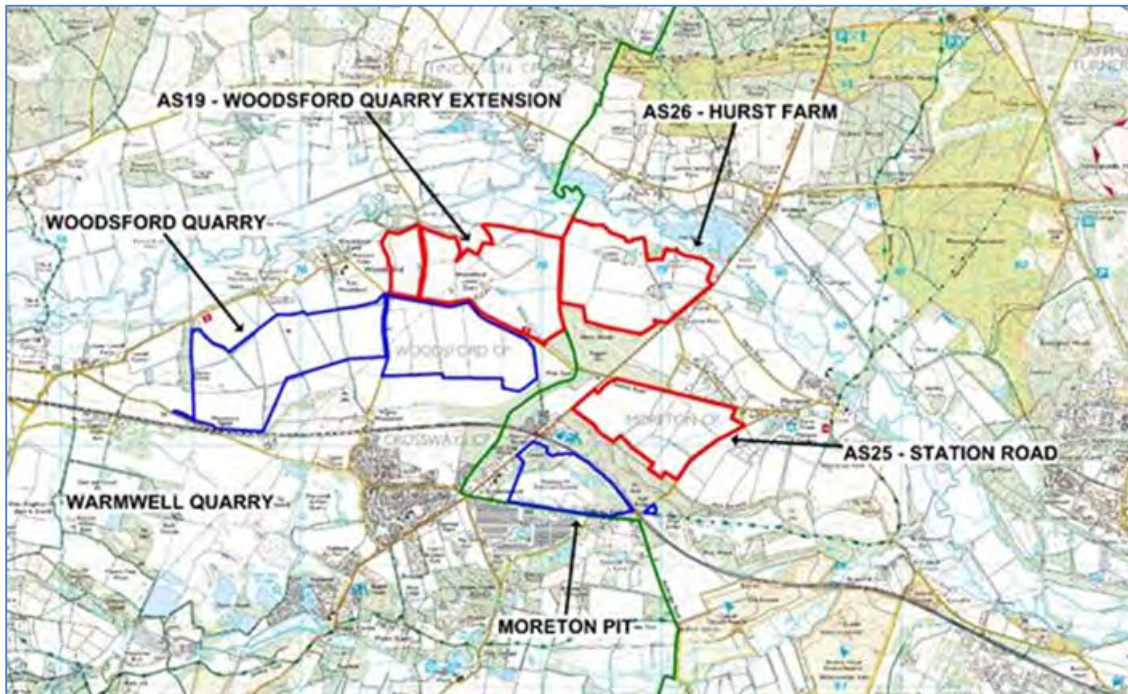

**Figure 4.1 – Location of Modelled Quarries**

- 4.15 Station Road and Hurst Farm quarries will not be working simultaneously. Only Station Road has been modelled for the purpose of this study as the two proposed sites are situated so close each other the model results will be similar for either quarry.
- 4.16 It is understood that quarry related traffic does not always have the same destinations, therefore future trip distribution of quarry related lorries has been based on observed traffic movements to/from Moreton Pit (Zone 24) and the manual traffic counts undertaken in May 2016.

### **Model Convergence**

- 4.17 The forecast models all ran successfully with assignments converging well. Networks are comparatively uncongested in all future scenarios. Convergence statistics are contained in **Appendix F**.

**5.0 MODEL RESULTS**

**Overall Network Statistics**

- 5.1 Each model run produces overall network statistic outputs. The network wide statistics are a useful way of comparing scenarios and give an indication of any congestion problems.
- 5.2 The network statistics for the base year, core forecast year, and each of the six forecast scenarios are contained in **Table 5.1**.

	2016 IP	2031 IP					
	BASE	SC0	SC1	SC2	SC3	SC4	SC5
Assigned Matrix Total	4107.44	4975.11	5249.11	5407.11	5613.11	5690.11	5931.11
Increase in Trips (Percent)	0	21.1	27.8	31.6	36.7	38.5	44.4
Transient Queues (pcu hrs)	17.6	23.7	26.2	27.7	29.5	30.3	32.6
Over-Capacity Queues (pcu hrs)	0.0	0.0	0.0	0.0	0.0	0.0	0.0
Total Travel Time (pcu hrs)	502.1	610.5	642.8	667.0	692.2	704.1	731.5
Travel Distance (pcu km)	46640.8	56517.0	58914.6	60654.6	62500.5	63348.1	65356.8
Average Speed (km/h)	92.9	92.6	91.7	90.9	90.3	90.0	89.4
Total Trips Loaded (pcu's)	4107.4	4975.1	5249.1	5407.1	5613.1	5690.1	5931.1

**Table 5.1 – Network Wide Statistics 2016 & 2031**

- 5.3 PCUs mentioned in Table 5.1 are Passenger Car Units. For modelling purposes all vehicles are modelled as PCUs. Cars and light vans are represented as 1.0 PCU. Smaller lorries as 1.5 PCUs and larger lorries as 2.3 PCUs.
- 5.4 The overall network statistics vary slightly for each scenario. Transient queues increase and average speeds decrease as the total trips loaded increases. However, even in the worst case Scenario 5, speeds are relatively high and transient queues low. None of the figures above raise any cause for concern.
- 5.5 The ‘Core’ 2031 forecast scenario (SC0) contains 21.1% more trips than the base 2016 year. The worst case SC5 scenario contains 44.4% more trips than the base.



**Overall Difference Plots**

5.6 Difference plots have been produced comparing traffic flows for each forecast scenario with the base model. The plots show increases in peak hour traffic in green and decreases in blue. Comparisons of each scenario against the base 2016 and core 2031 are shown in **Figure 5.2** to **Figure 5.12**.

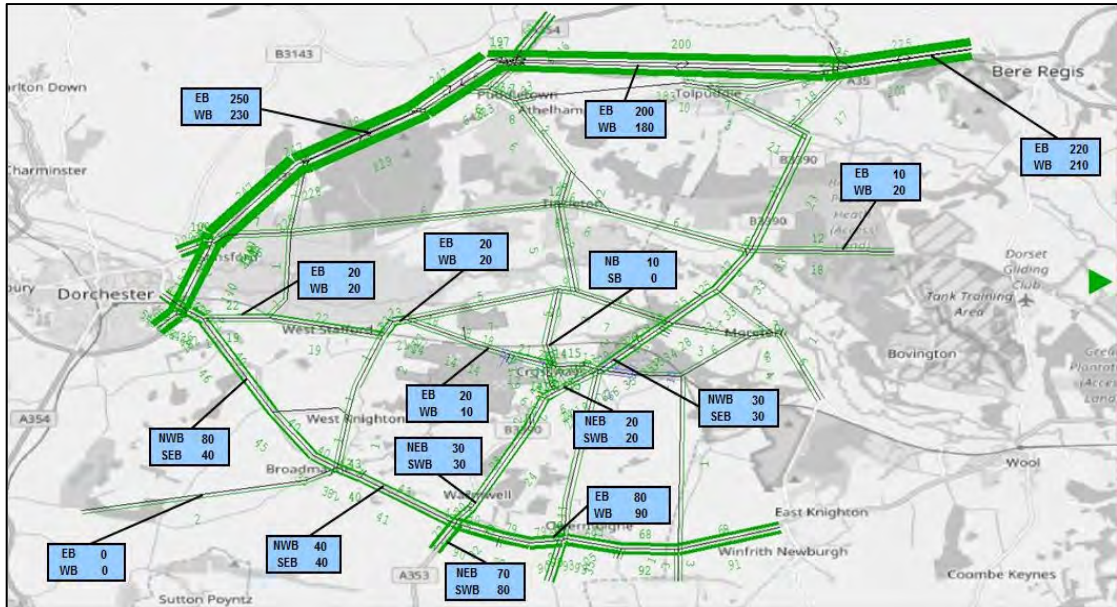

**Figure 5.2 – Scenario SC0 2031 vs. Base 2016 Inter Peak**

5.7 Scenario SC0 is the Core 2031 forecast which does not include local development trips in Crossways and Moreton (i.e. background growth only). This scenario contains 21.1% more trips than the 2016 base model. The greatest increase is along the A35 trunk road with an additional 230 to 250 PCUs in each direction. There is an increase of around 80 to 90 PCUs using the A352 between Warmwell Roundabout and East Knighton in each direction. There are only small increases predicted in the B3390 / Crossways area.

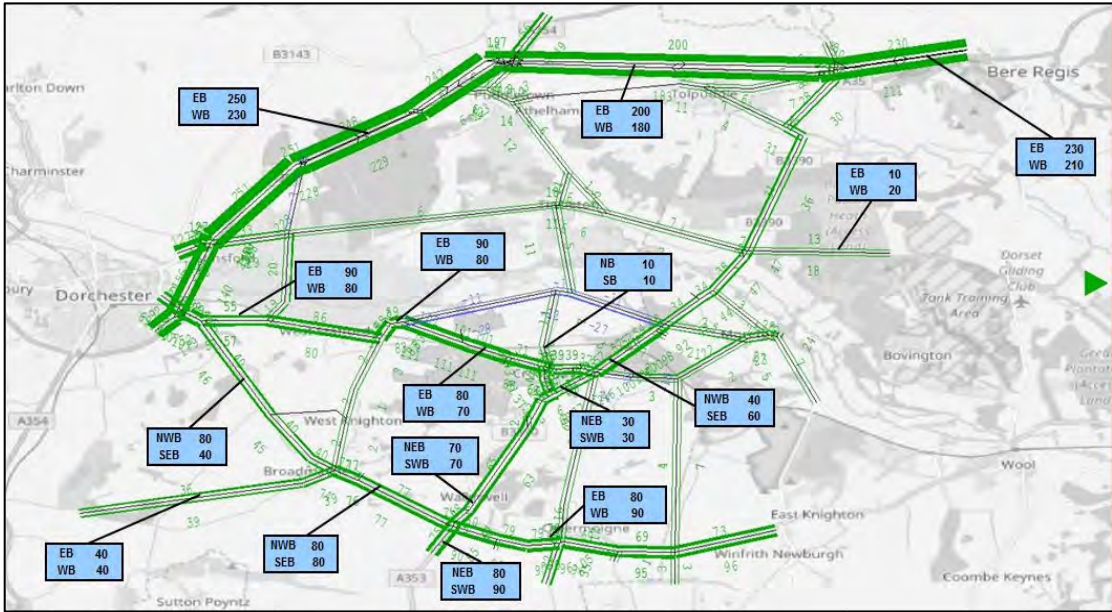

Figure 5.3 – Scenario SC1 2031 vs. Base 2016 Inter Peak

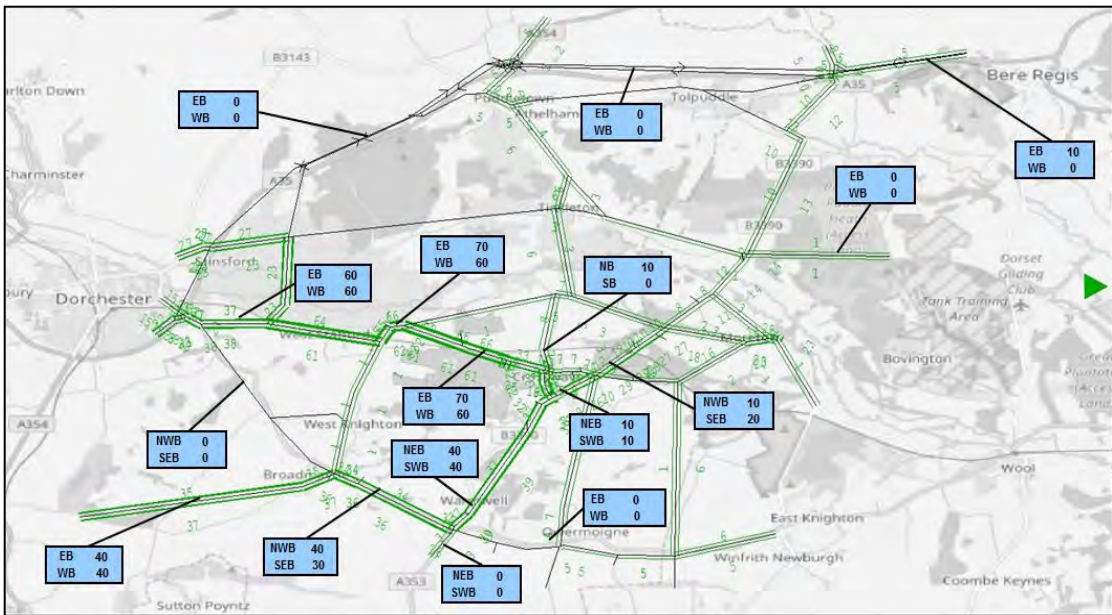

Figure 5.4 – Scenario SC1 2031 vs. Scenario SC0 2031 Inter Peak

5.8 Scenario SC1 contains 640 dwellings in Crossways and Moreton area in addition to the ‘Core’ background growth. This scenario contains 27.8% more trips than the 2016 base model. **Figure 5.3** shows the overall impact and **Figure 5.4** shows the impact of the 640 dwelling in isolation.



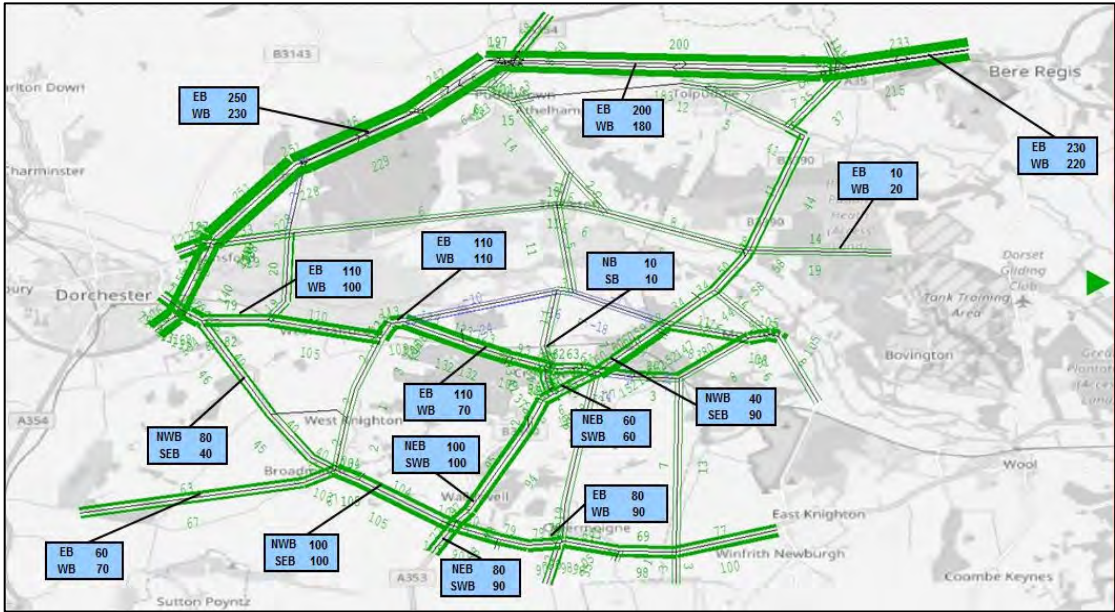

Figure 5.5 – Scenario SC2 2031 vs. Base 2016 Inter Peak

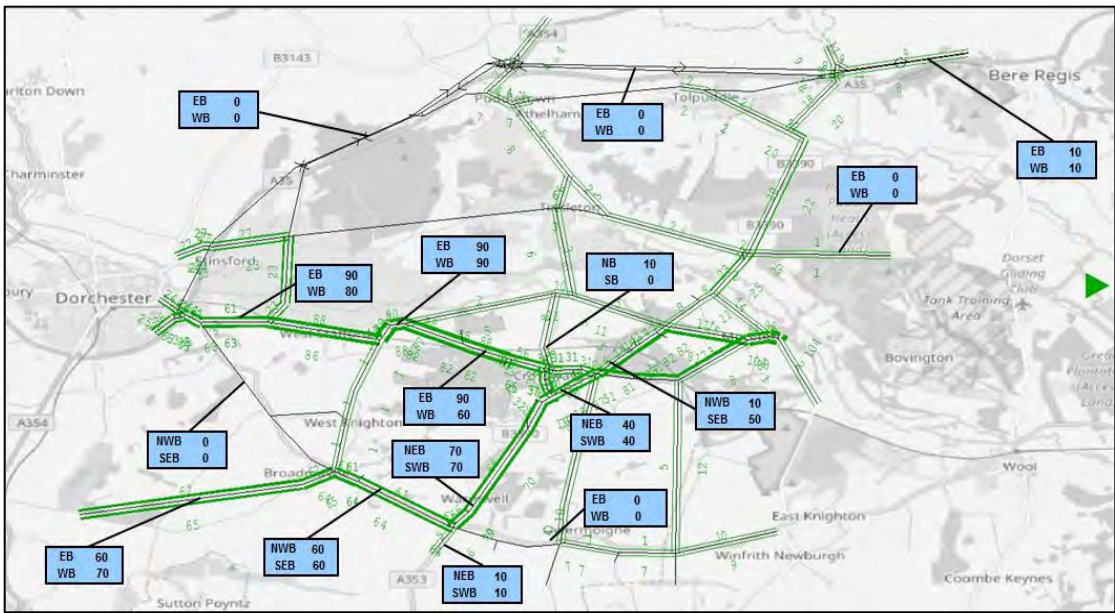

Figure 5.6 – Scenario SC2 2031 vs. Scenario SC0 2031 Inter Peak

5.9 Scenario SC2 contains 1,140 dwellings in Crossways and Moreton area in addition to the ‘Core’ background growth. This scenario contains 31.6% more trips than the 2016 base model. **Figure 5.5** shows the overall impact and **Figure 5.6** shows the impact of the 1,140 dwellings in isolation.

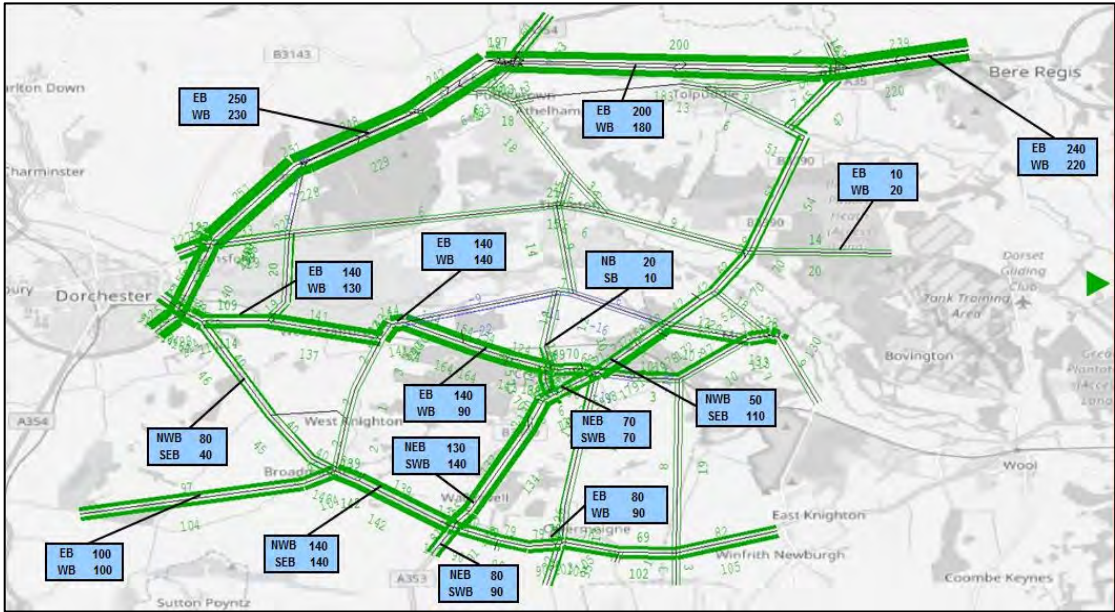

Figure 5.7 – Scenario SC3 2031 vs. Base 2016 Inter Peak

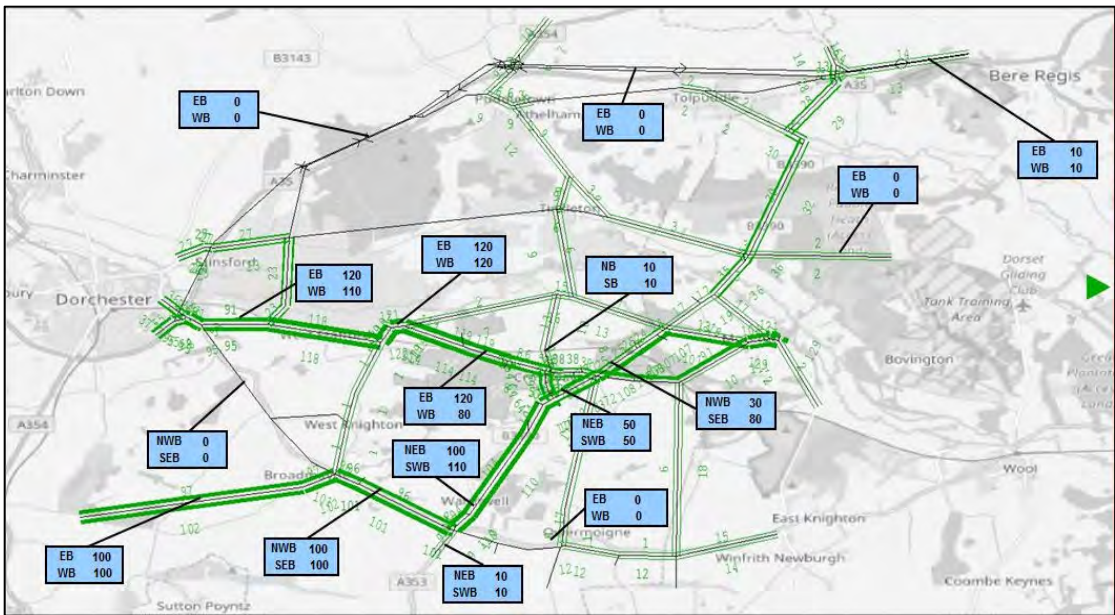

Figure 5.8 – Scenario SC3 2031 vs. Scenario SC0 2031 Inter Peak

5.10 Scenario SC3 contains 1,790 dwellings in Crossways and Moreton area in addition to the ‘Core’ background growth. This scenario contains 36.7% more trips than the 2016 base model. **Figure 5.7** shows the overall impact and **Figure 5.8** shows the impact of the 1,790 dwellings in isolation.



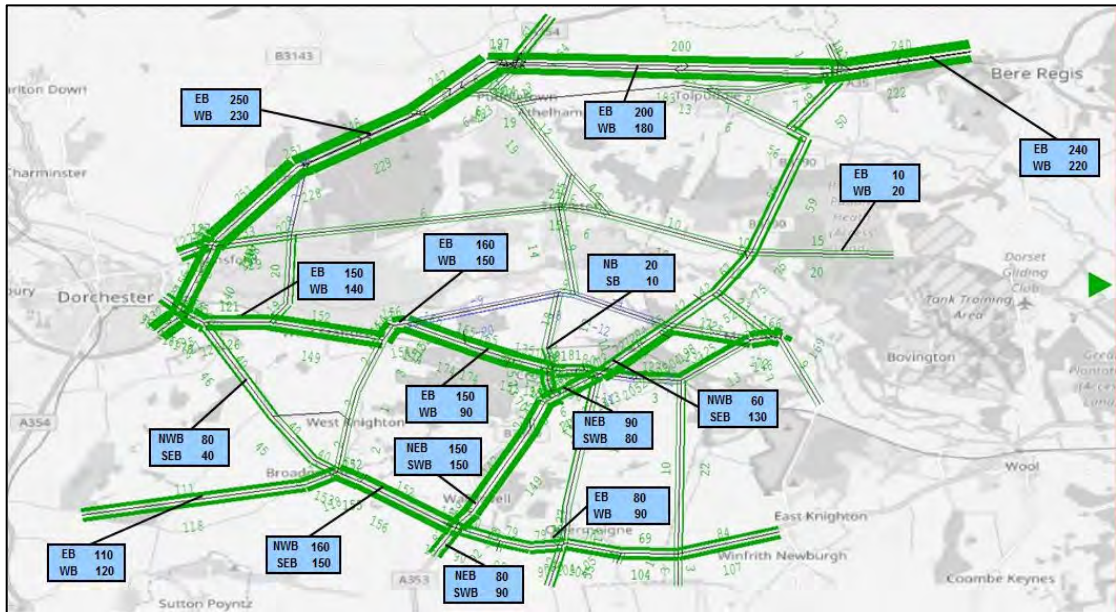

Figure 5.9 – Scenario SC4 2031 vs. Base 2016 Inter Peak

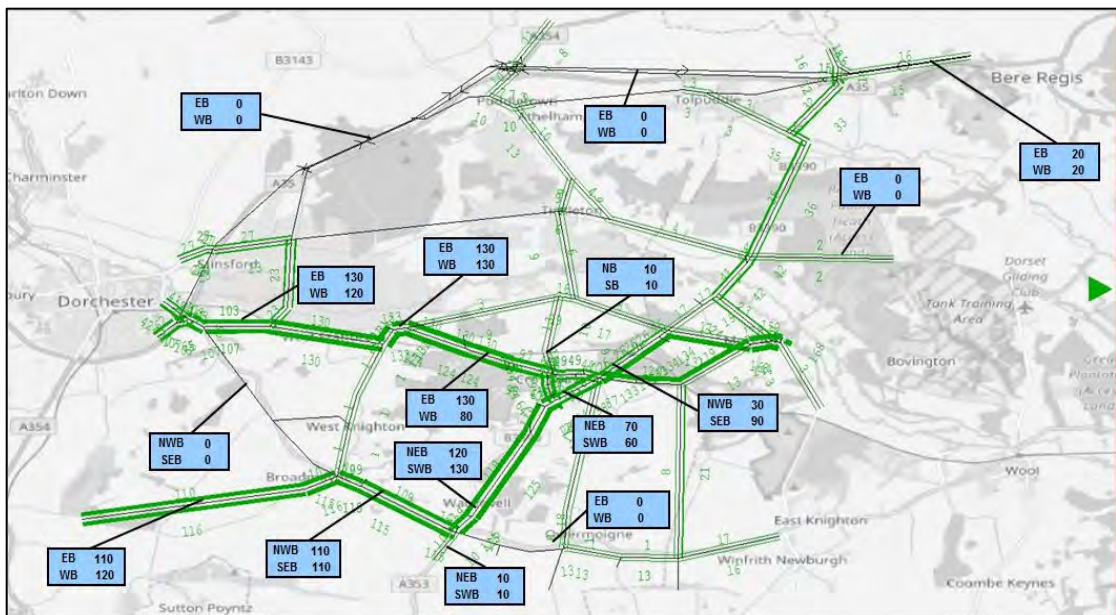

Figure 5.10 – Scenario SC4 2031 vs. Scenario SC0 2031 Inter Peak

5.11 Scenario SC4 contains 2,040 dwellings in Crossways and Moreton area in addition to the 'Core' background growth. This scenario contains 38.5% more trips than the 2016 base model. **Figure 5.9** shows the overall impact and **Figure 5.10** shows the impact of the 2,040 dwellings in isolation.



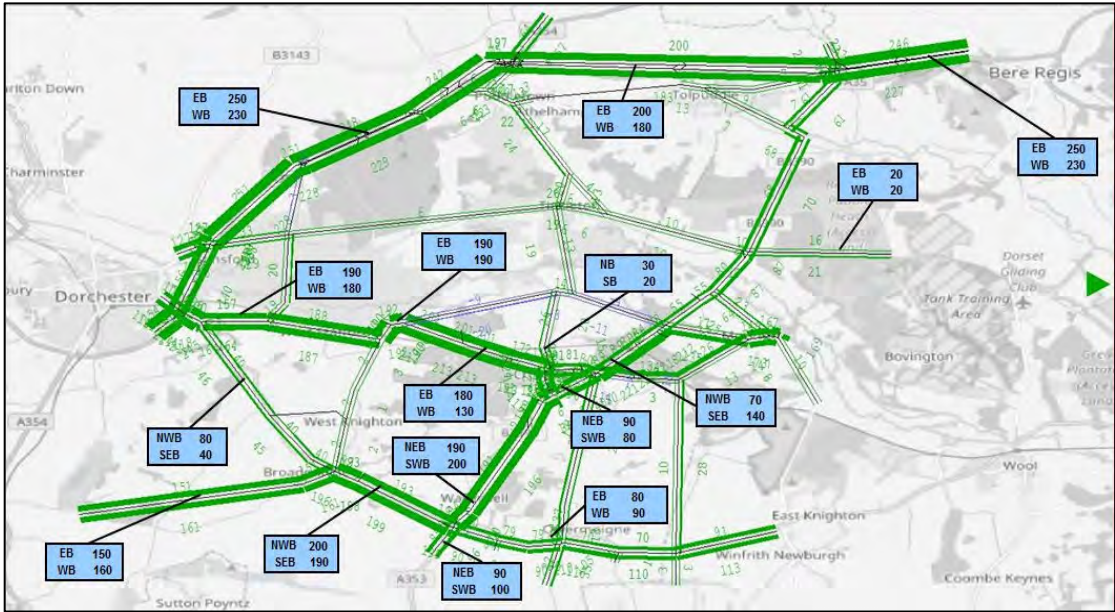

Figure 5.11 – Scenario SC5 2031 vs. Base 2016 Inter Peak

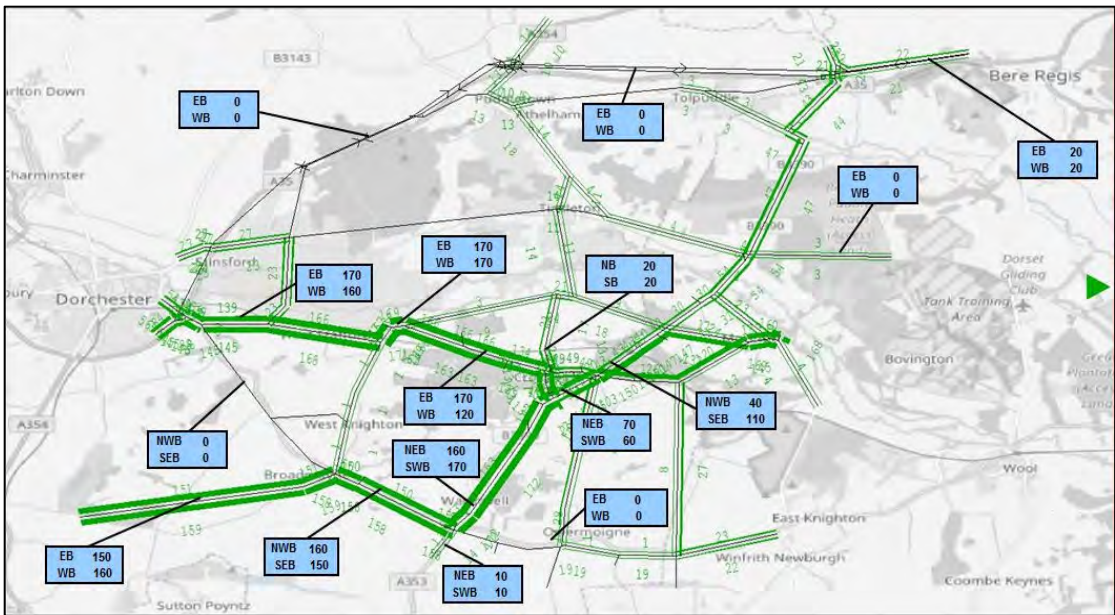
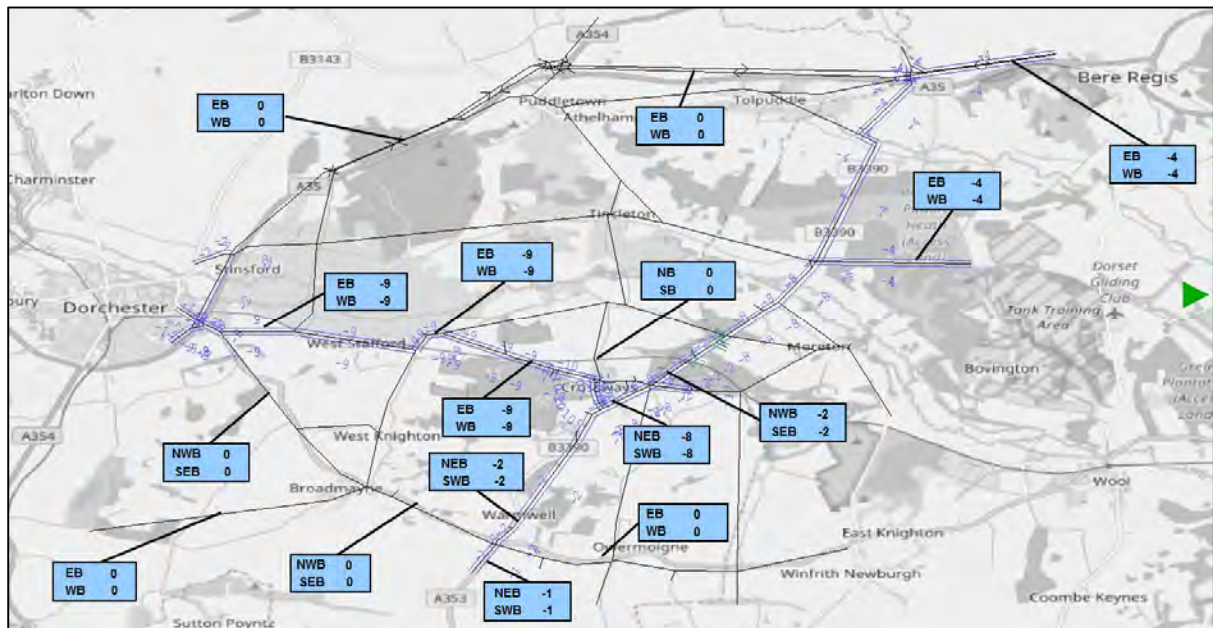

Figure 5.12 – Scenario SC5 2031 vs. Scenario SC0 2031 Inter Peak

5.12 Scenario SC5 contains 2,800 dwellings in Crossways and Moreton area in addition to the ‘Core’ background growth. This scenario contains 44.4% more trips than the 2016 base model. **Figure 5.11** shows the overall impact and **Figure 5.12** shows the impact of the 2,800 dwellings in isolation.

### Quarry Traffic Difference Plots

5.13 A difference plot has been produced comparing quarry traffic flows for 2031 Scenario SC0 against the Base 2016 model. The plots are shown in **Figure 5.13**.



**Figure 5.13 Quarry HGV Traffic 2031 Forecast vs. 2016 Base**

- 5.14 It has been stated that the proposed quarries at Hurst Farm and Station Road will not operate simultaneously. Therefore, the plot shows the effect of only Woodsford and Station Road quarries being operational in 2031. The plot would be almost identical if only Woodsford and Hurst Farm quarries were open.
- 5.15 It is predicted that only two quarries will be operating simultaneously from 2020 (compared with three in 2016). Therefore, quarry related traffic is predicted to be lower than current levels.

## Key Locations

- 5.17 As the overall model statistics did not show any causes for concern, only traffic impacts for the worst-case future scenario have been compared against the 'Core' future scenario (SC0) at the following key locations:

### Links

- B3390 North of Crossways (ATC 355) (Moreton Level Crossing)
- B3390 South of Crossways (ATC 1451)
- C33 West Stafford Bypass (ATC 1395)
- C80 East of B3390 (ATC 1394)
- A35 East of A354 (ATC 2464)
- Highgate Lane (ATC 1450) (Woodsford No.38 Level Crossing)

### Junctions

- Dorchester Bypass / Wareham Road Junction (Site 5138-0311)
- Max Gate Roundabout (Site 5138-0211)
- Warmwell Roundabout (Node 50162)
- A31 / A35 Bere Regis Roundabout
- B3390 North of Crossways

- 5.18 To provide an indication of the predicted traffic impact on the key links, graphs of weekday traffic profiles have been produced (**Figure 5.14** to **Figure 5.25**). Each graph shows observed traffic data from 2016 and 2008 (when traffic flows were generally greater in the Crossways area). Also plotted are modelled flows for the worst case forecast scenario (SC5).

- 5.19 The model shows the highway network will be able to accommodate the predicted future traffic however; the traffic flow profile graphs should give an idea of how busy roads may be compared with current conditions.

- 5.20 To provide an indication of the predicted traffic impact on the key junctions, node diagrams have been produced (**Figure 5.24** to **Figure 5.31**). The diagrams show the predicted increase in traffic (PCUs) and the predicted volume over capacity (V/C) ratio for each movement.

- 5.21 The volume over capacity ratio is a common measure to show possible congestion. Any movement with a volume over capacity ratio greater than 85% is likely to experience congestion. None of the junctions assessed for this study show V/C ratios greater than 85%. Therefore, congestion in the inter-peak period is unlikely.

5.22 Average weekday traffic flow profiles for the B3390 North of Crossways are shown in **Figure 5.14** and **Figure 5.15** for north-eastbound and south-westbound directions respectively.

5.23 Current (2016) traffic flow profiles on the B3390 North of Crossways show peak flows of approximately 270 and 330 vehicles per hour. The model predicts an Inter-Peak increase of approximately 40% in the NB direction and 95% in the SB direction for SC5 forecast. The graphs below show the predicted SB Inter-Peak traffic in SC5 forecast is likely to be much higher than the current PM peak. This could cause additional queuing, particularly southbound towards Moreton Level Crossing.

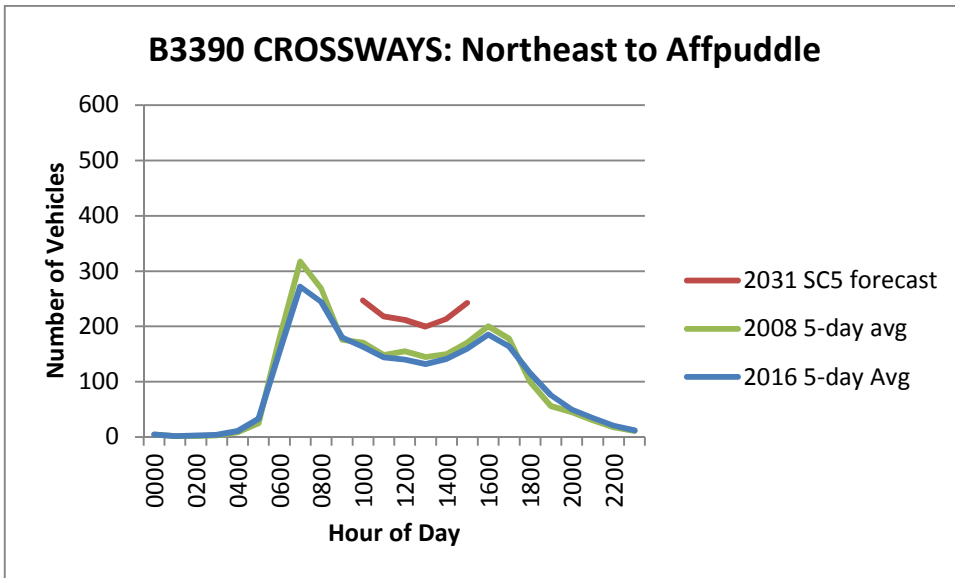

**Figure 5.14 B3390 North of Crossways Traffic Flow Profiles (North-Eastbound)**

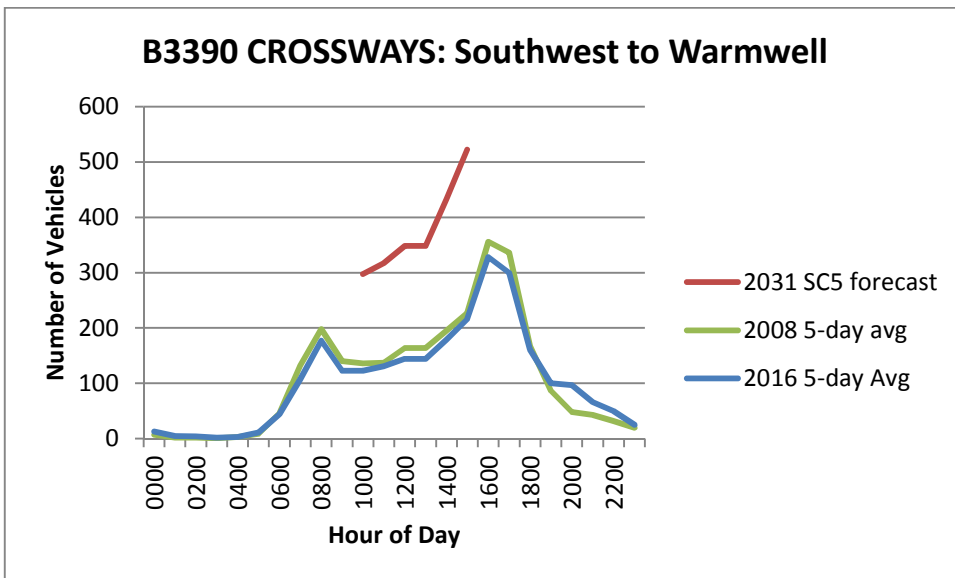

**Figure 5.15 B3390 North of Crossways Traffic Flow Profiles (South-Westbound) B3390 South of Crossways**

5.24 Average weekday traffic flow profiles for the B3390 South of Crossways are shown in **Figure 5.16** and **Figure 5.17** for north-eastbound and south-westbound directions respectively.

5.25 Current (2016) traffic flow profiles on the B3390 South of Crossways show peak flows of approximately 160 and 230 vehicles per hour. The model predicts an Inter-Peak increase of approximately 170% in the north-eastbound direction and 125% in the south-westbound direction for SC5 forecast. The graphs below show the predicted NB Inter-Peak traffic in SC5 forecast is likely to be higher both the current AM and PM peaks. This could cause additional queuing, particularly southbound at Woodsford No.38 Level Crossing.

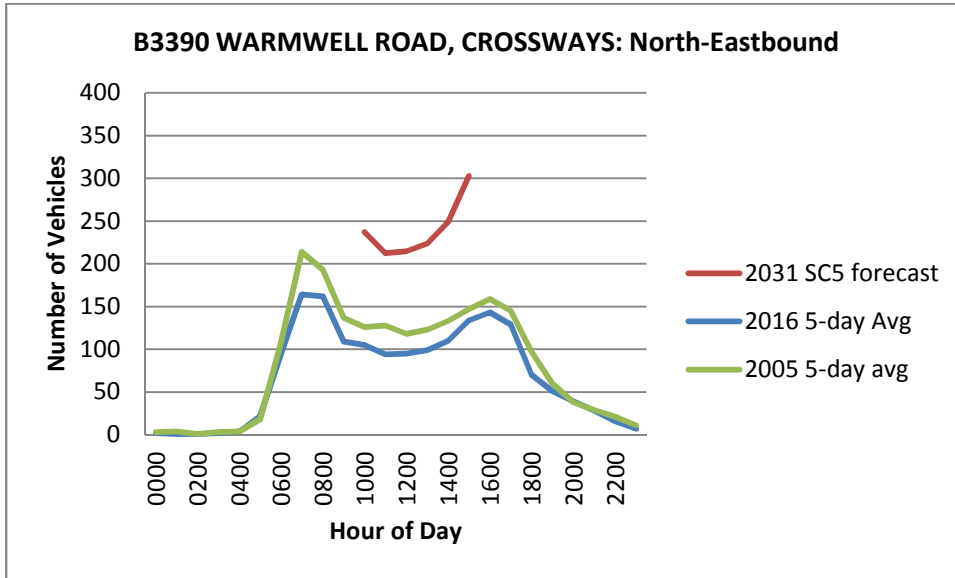

**Figure 5.16 B3390 South of Crossways Traffic Flow Profiles (North-Eastbound)**

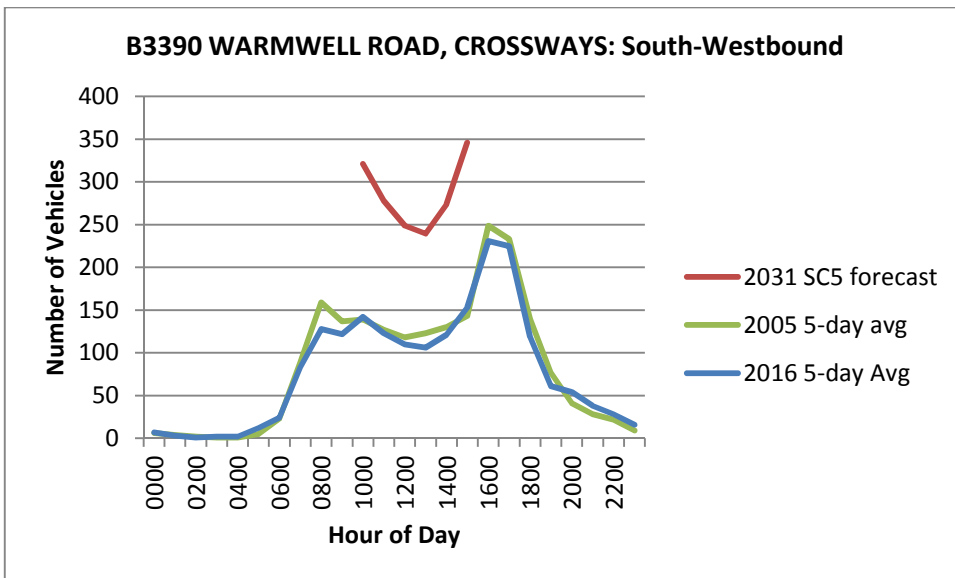
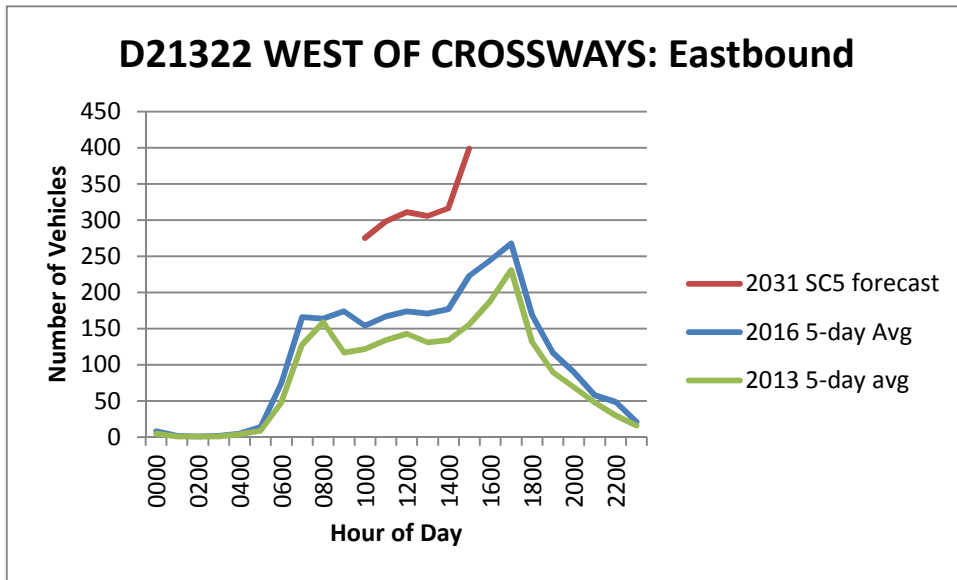

**Figure 5.17 B3390 South of Crossways Traffic Flow Profiles (South-Westbound)**



**D21322 West of Crossways (Highgate Lane)**

- 5.26 Average weekday traffic flow profiles for the D21322 West of Crossways are shown in **Figure 5.18** and **Figure 5.19** for eastbound and westbound directions respectively.
- 5.27 Current (2016) traffic flow profiles on the D21322 West of Crossways show peak flows of approximately 250 and 300 vehicles per hour. The model predicts an Inter-Peak increase of approximately 70% in the EB and 45% in the WB direction for SC5 forecast. The graphs below show the predicted EB Inter-Peak traffic in SC5 forecast is likely to be higher than the current PM peak.



**Figure 5.18 West of Crossways Traffic Flow Profiles (Eastbound)**

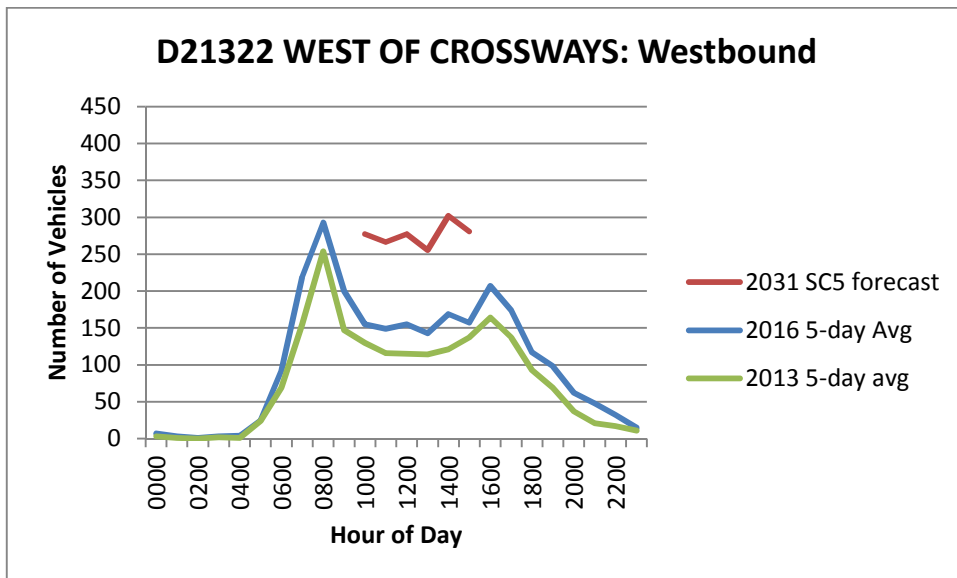
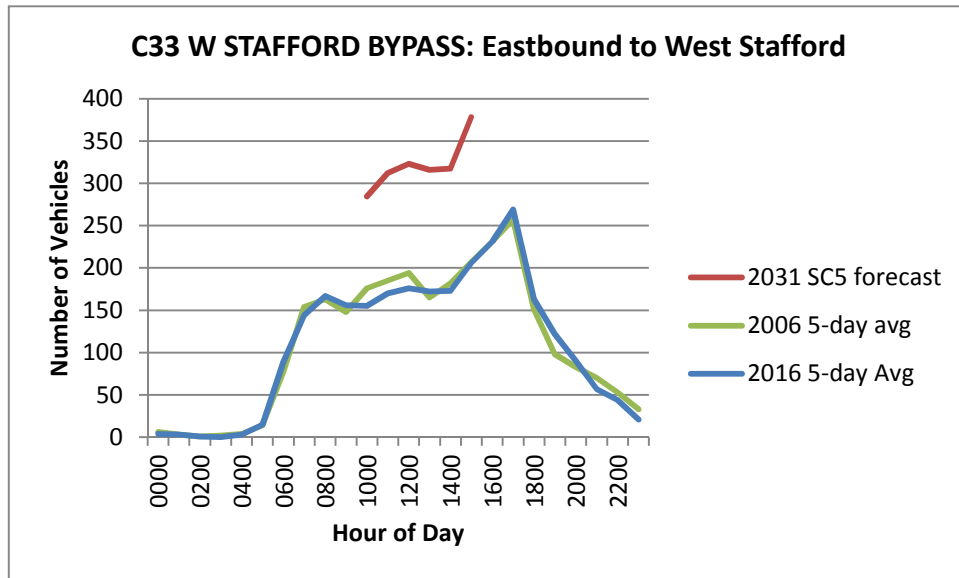

**Figure 5.19 West of Crossways Traffic Flow Profiles (Westbound)**



**C33 West Stafford Bypass**

- 5.28 Average weekday traffic flow profiles for the C33 West Stafford Bypass are shown in **Figure 5.20** and **Figure 5.21** for eastbound and westbound directions respectively.
- 5.29 Current (2016) traffic flow profiles on the C33 West Stafford Bypass show peak flows of approximately 320 and 270 vehicles per hour. The model predicts an Inter-Peak increase of approximately 90% in each direction for the SC5 forecast. The graphs below show the predicted EB Inter-Peak traffic in SC5 forecast is likely to be higher than the current PM peak.



**Figure 5.20 C33 West Stafford Bypass Traffic Flow Profiles (Eastbound)**

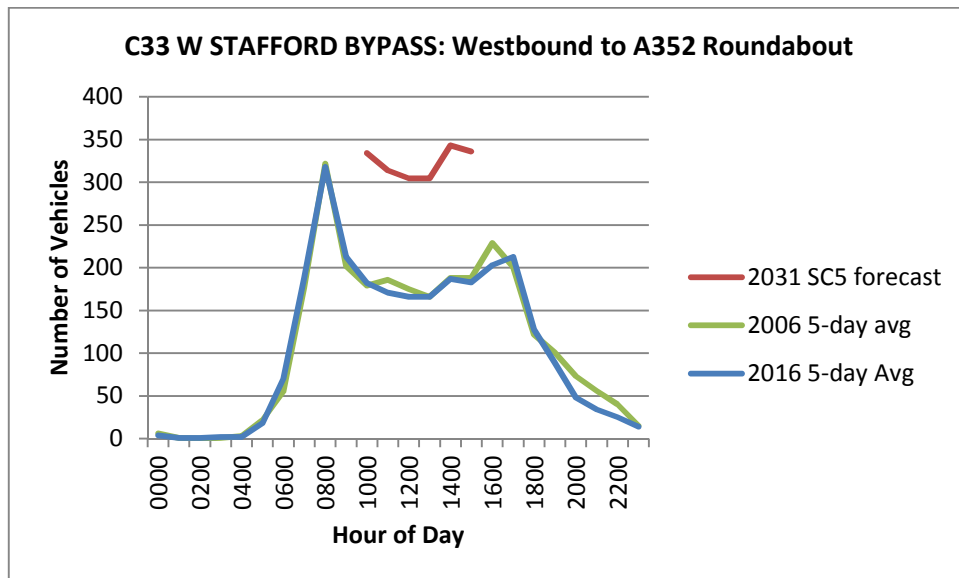

**Figure 5.21 C33 West Stafford Bypass Traffic Flow Profiles (Westbound)**

**C80 East of B3390**

- 5.30 Average weekday traffic flow profiles for the C80 East of B3390 are shown in **Figure 5.22** and **Figure 5.23** for eastbound and westbound directions respectively.
- 5.31 Current (2016) traffic flow profiles on the C33 West Stafford Bypass show peak flows of approximately 270 and 310 vehicles per hour. The model predicts an Inter-Peak decrease of less than 1% in the EB direction and an increase of less than 10% in the WB direction for SC5 forecast. The graphs below show the predicted Inter-Peak traffic in SC5 forecast is likely to remain at the current volume.

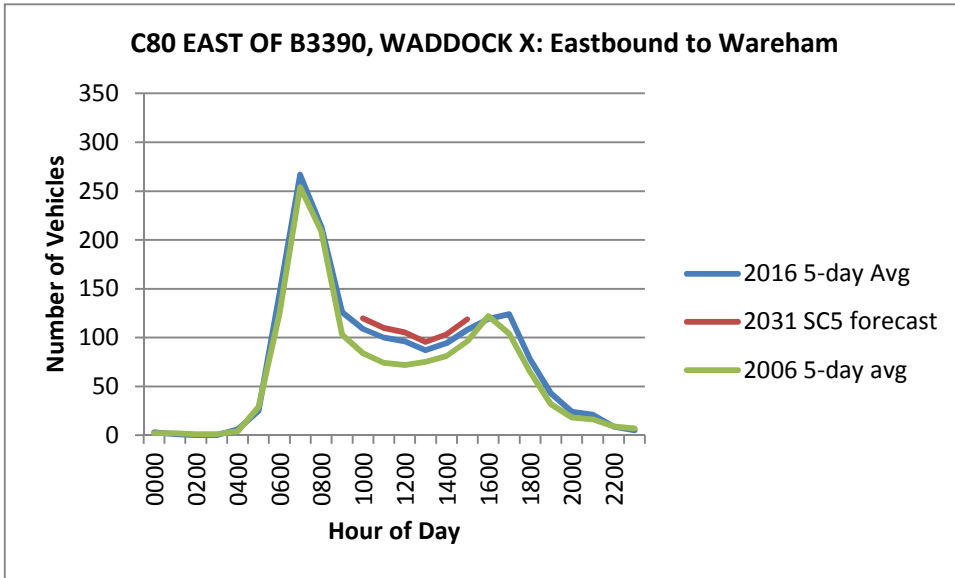

**Figure 5.22 C80 East of B3390 Traffic Flow Profiles (Eastbound)**

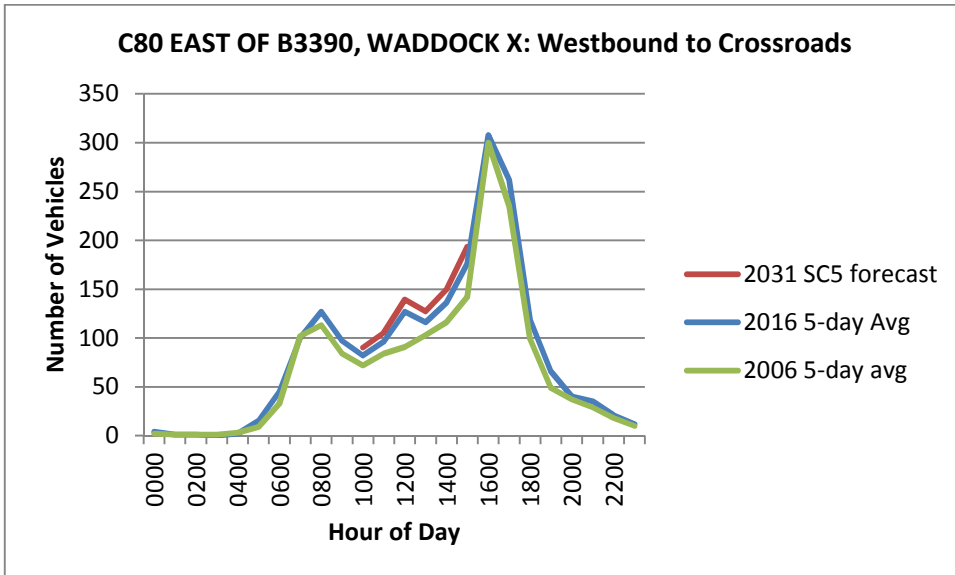

**Figure 5.23 C80 East of B3390 Traffic Flow Profiles (Westbound)**

**A35 East of A354 Northbrook Interchange (Puddletown Bypass)**

- 5.32 Average weekday traffic flow profiles for the A35 East of A354 are shown in **Figure 5.24** and **Figure 5.25** for eastbound and westbound directions respectively.
- 5.33 Current (2016) traffic flow profiles on the A35 East of A354 show peak flows of between 1000 and 1100 vehicles per hour. The model predicts an Inter-Peak increase of approximately 20% in each direction for the SC5 forecast. The graphs below show the predicted EB Inter-Peak traffic in SC5 forecast is likely to be higher than the current AM and PM peaks.

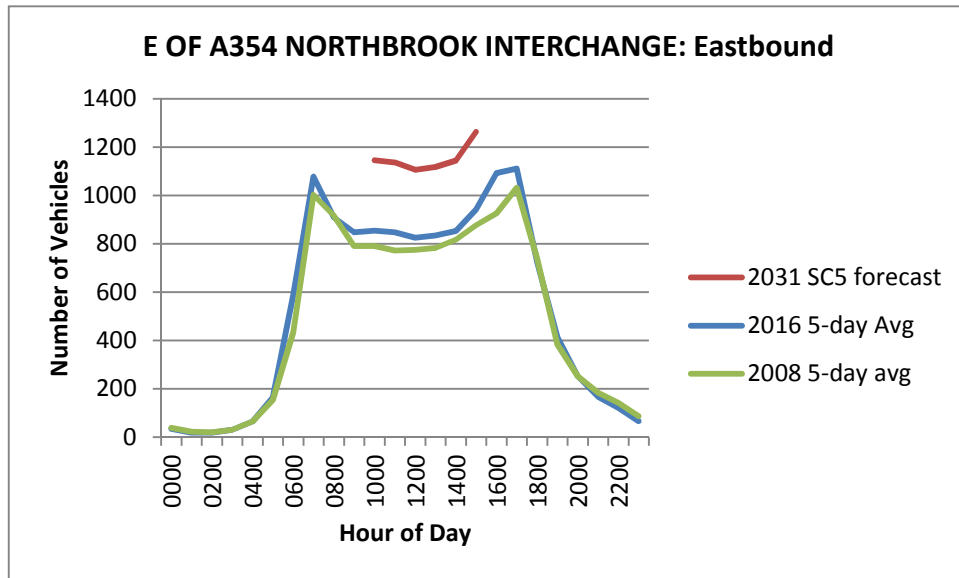

**Figure 5.24 A35 East of A354 Traffic Flow Profiles (Eastbound)**

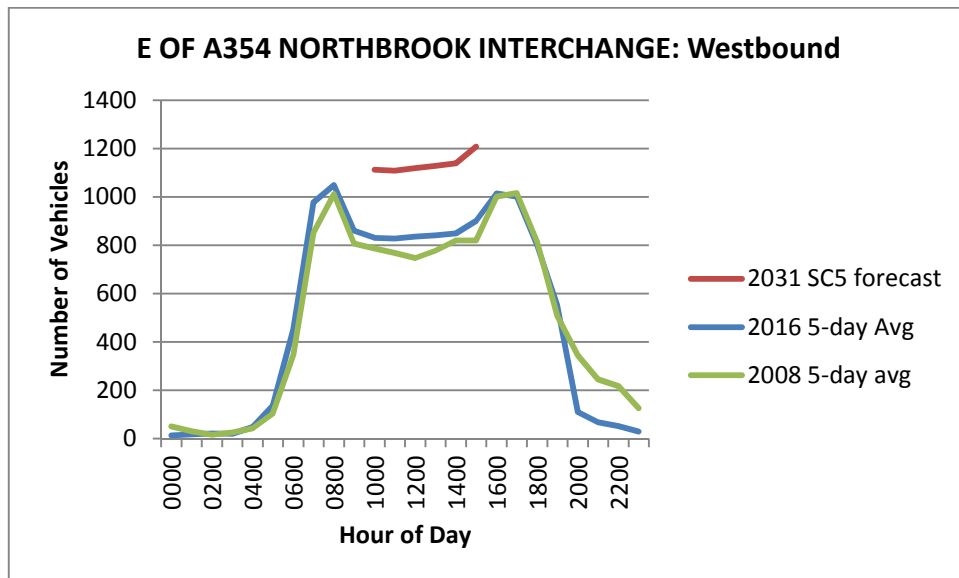

**Figure 5.25 A35 East of A354 Traffic Flow Profiles (Westbound)**

**A35 Dorchester Bypass / A352 Wareham Road Junction**

- 5.34 Model output diagrams for the A35 / A352 junction are shown **Figure 5.26** and **Figure 5.27** for demand flows and volume over capacity percentages respectively.
- 5.35 A comparison of predicted worst case scenario SC5 flows against background growth scenario SC0 flows shows an impact of an additional 102 PCU's entering the A35 and 111 PCUs exiting the A35 at this junction.

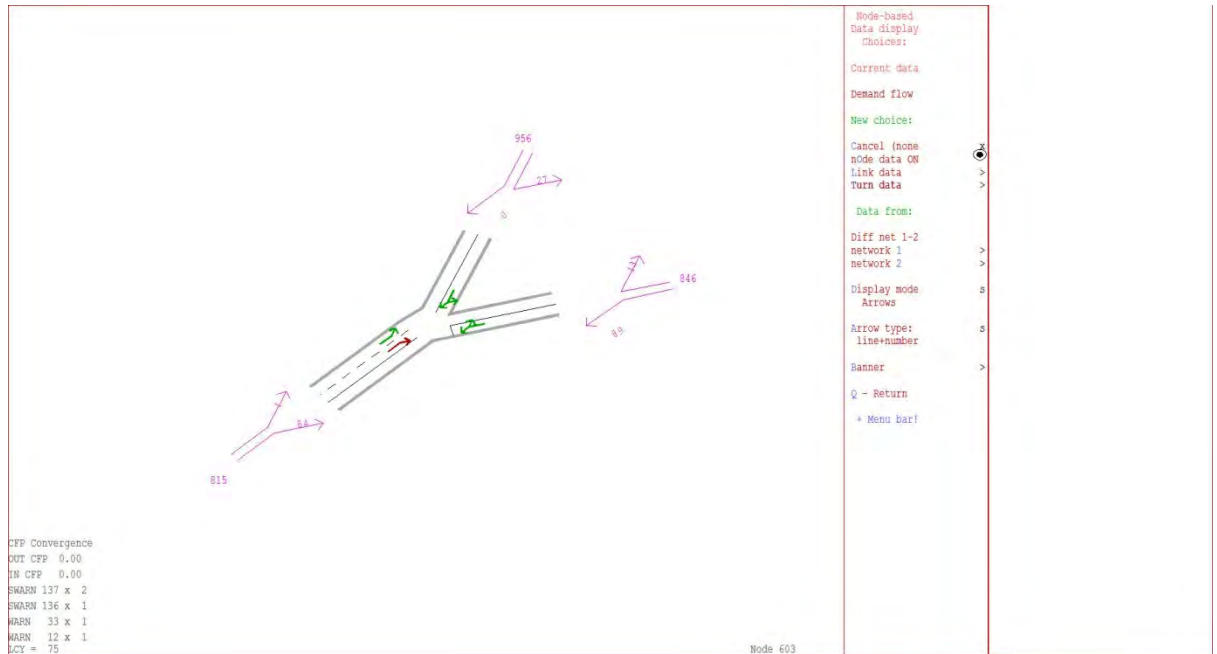

**Figure 5.26 A35 /A352 Junction SC5 vs. SC0 Demand Flow Impact (PCUs)**

- 5.36 The greatest volume over capacity figure in worst case scenario SC5 is 45% to traffic turning left onto the A35. This is below the 85% considered to be an issue.

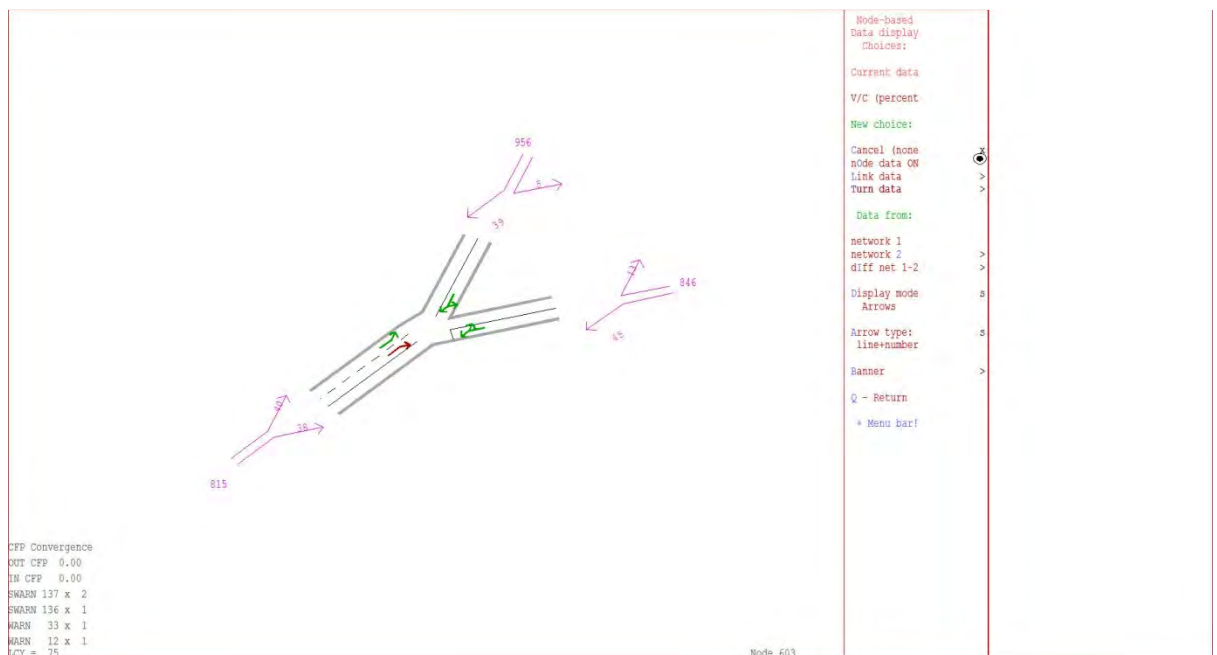

**Figure 5.27 A35 /A352 Junction Volume over Capacity Percentages**

**A352 / B3144 Max Gate Roundabout**

- 5.37 Model output diagrams for the A352 / B3144 junction are shown **Figure 5.28** and **Figure 5.29** for demand flows and volume over capacity percentages respectively.
- 5.38 A comparison of predicted worst case scenario SC5 flows against background growth scenario SC0 flows shows an impact of an additional 323 PCU's entering the junction in the inter-peak.

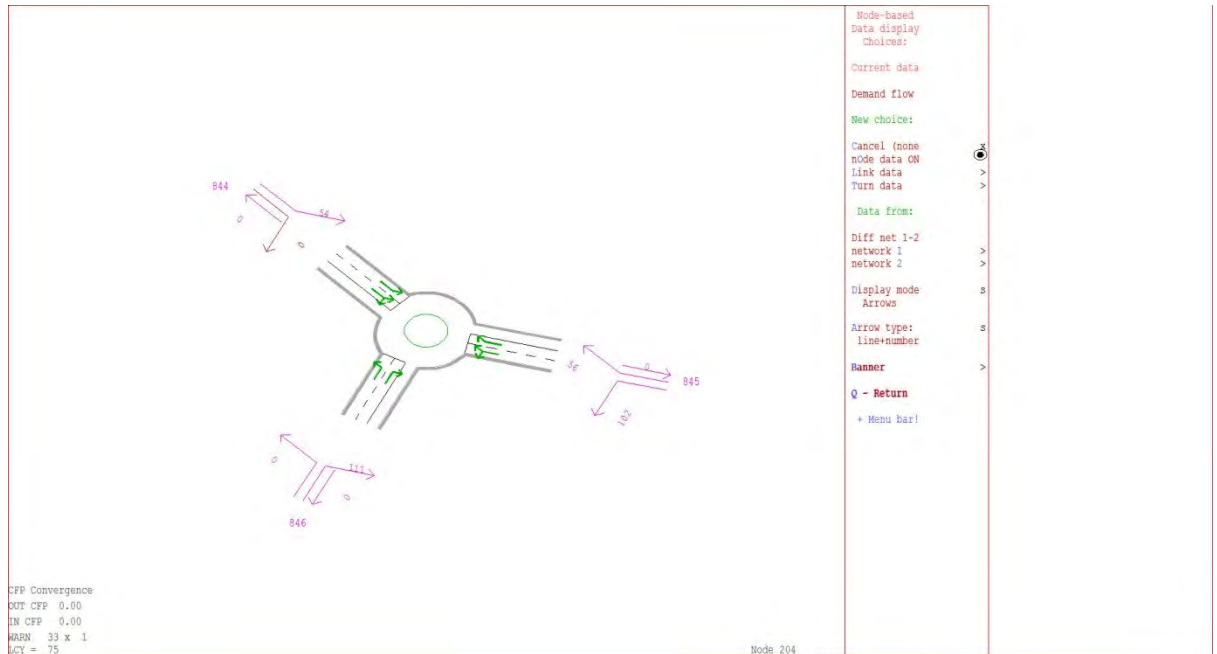

**Figure 5.28 Max Gate Roundabout SC5 vs. SC0 Demand Flow Impact (PCUs)**

- 5.39 The greatest volume over capacity figure in worst case scenario SC5 is 24% for traffic entering Dorchester. This is below the 85% considered to be an issue.

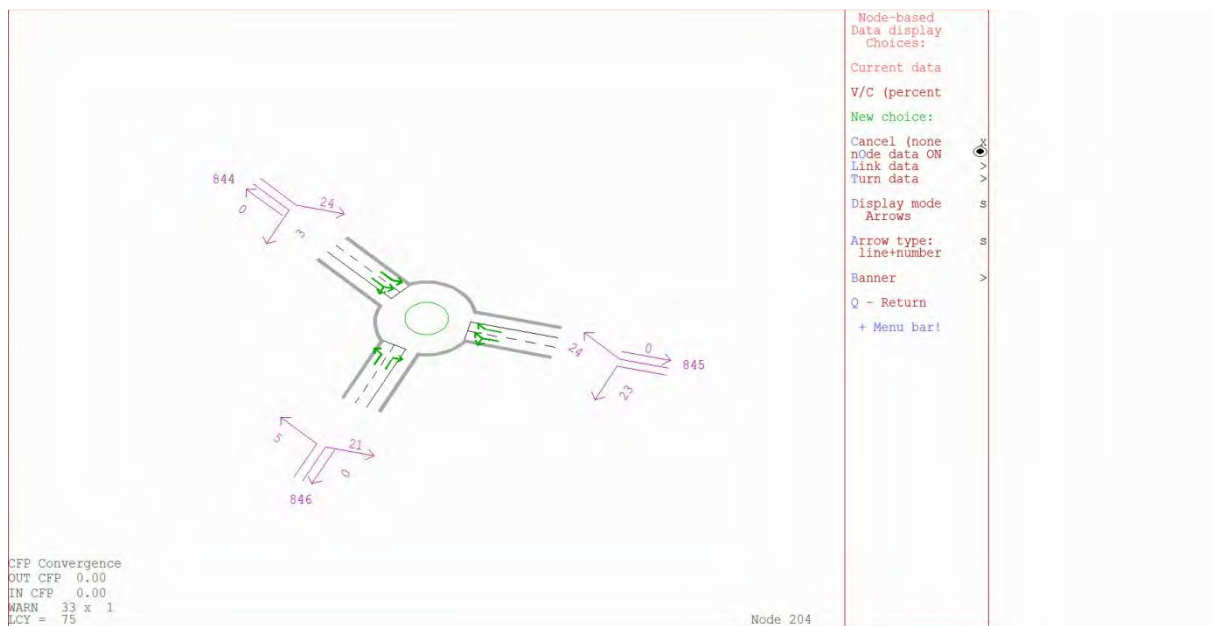

**Figure 5.29 Max Gate Roundabout Volume over Capacity Percentages**

**A352 / C33 West Stafford Bypass Roundabout**

- 5.40 Model output diagrams for the A352 / C33 junction are shown **Figure 5.30** and **Figure 5.31** for demand flows and volume over capacity percentages respectively.
- 5.41 A comparison of predicted worst case scenario SC5 flows against background growth scenario SC0 flows shows an impact of an additional 325 PCU's entering the junction in the inter-peak. All of this traffic is travelling between the C33 and the A352 (Dorchester direction).

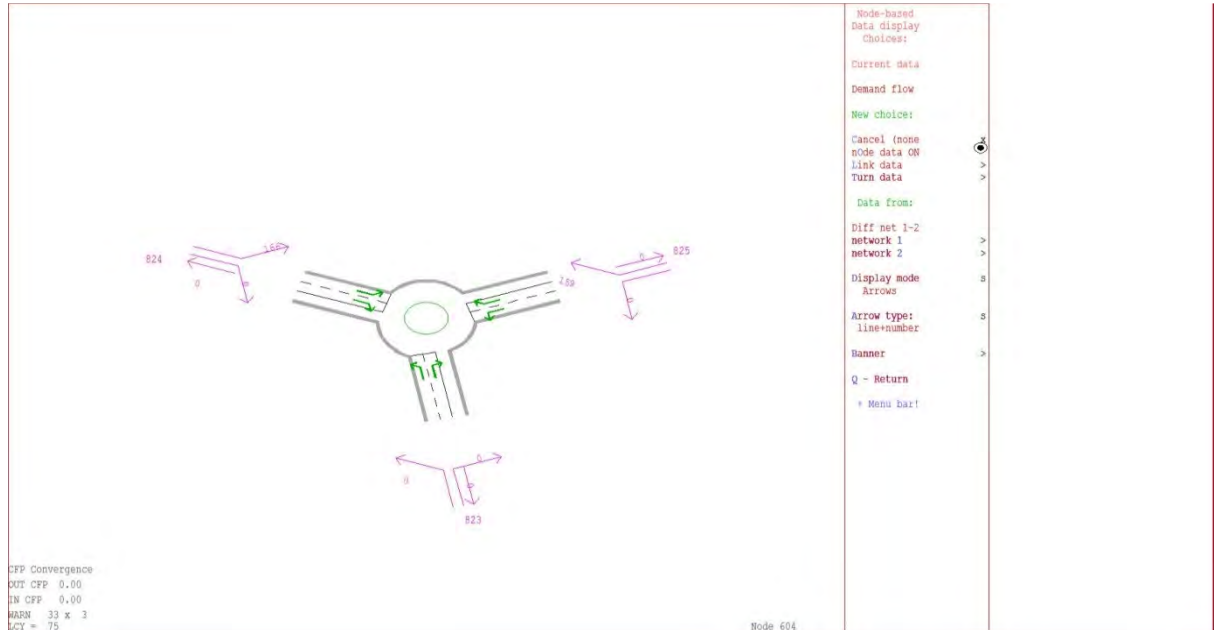

**Figure 5.30 West Stafford Bypass SC5 vs. SC0 Demand Flow Impact (PCUs)**

- 5.42 The greatest volume over capacity figure in worst case scenario SC5 is 22% for traffic heading from A352 (Dorchester Direction). This is below the 85% considered to be an issue.

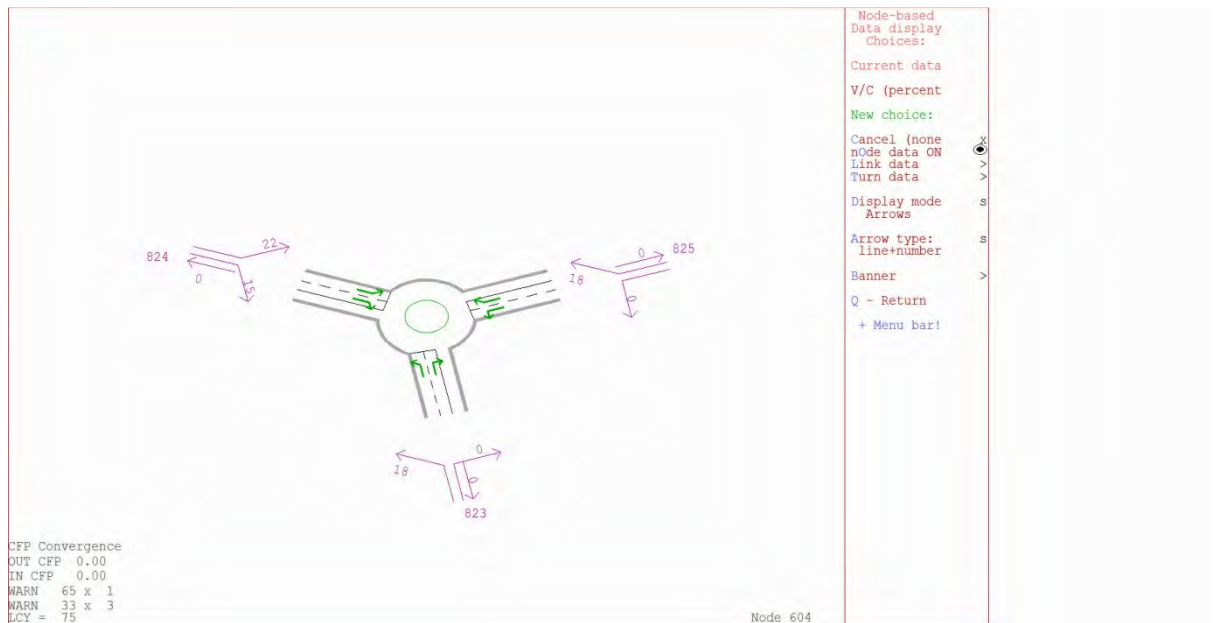
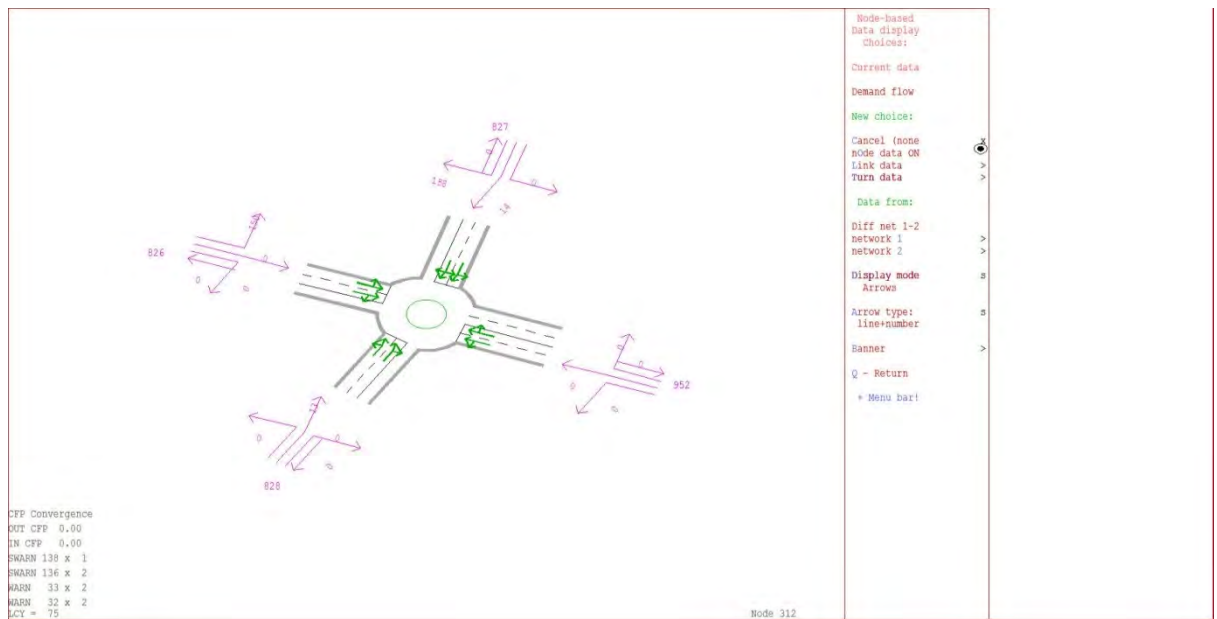

**Figure 5.31 West Stafford Bypass Volume over Capacity Percentages**



**A352 / B3390 Warmwell Roundabout**

- 5.43 Model output diagrams for the A352 / B3390 junction are shown **Figure 5.32** and **Figure 5.33** for demand flows and volume over capacity percentages respectively.
- 5.44 A comparison of predicted worst case scenario SC5 flows against background growth scenario SC0 flows shows an impact of an additional 335 PCU's entering the junction in the inter-peak. The majority of additional traffic is travelling to/from the B3390 Warmwell to/from A352 Broadmayne.



**Figure 5.32 Warmwell Roundabout SC5 vs. SC0 Demand Flow Impact (PCUs)**

- 5.45 The greatest volume over capacity figure in worst case scenario SC5 is 18% for traffic leaving Warmwell. This is below the 85% considered to be an issue.

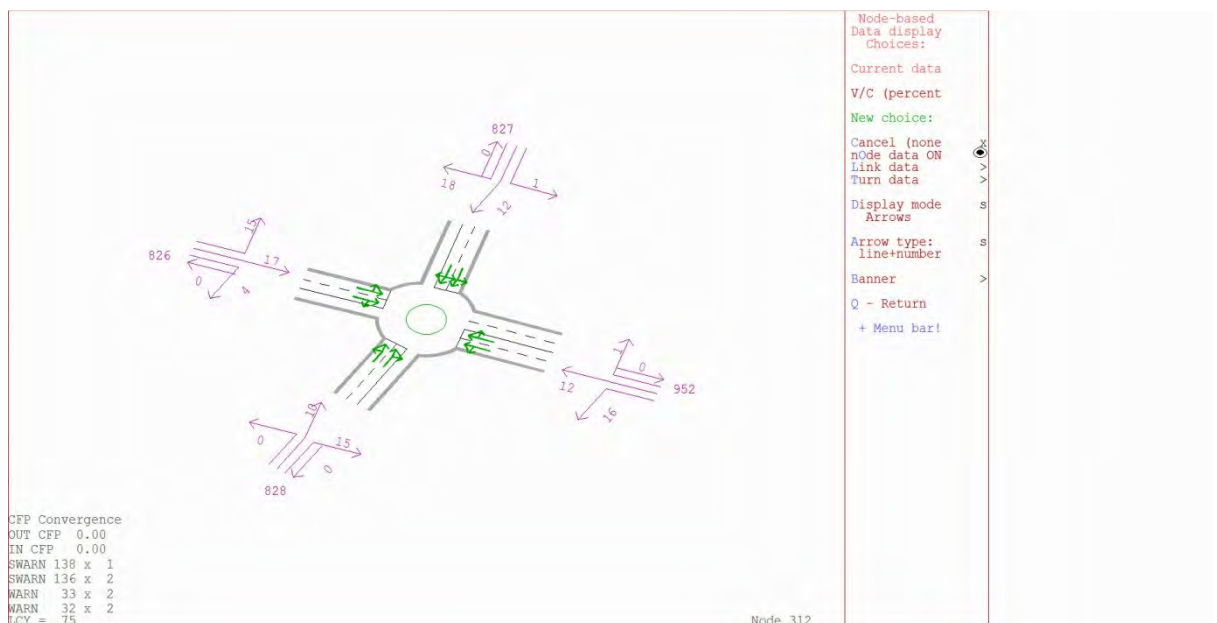

**Figure 5.33 Warmwell Roundabout Volume over Capacity Percentages**

**A31 / A35 Bere Regis Roundabout**

5.46 The A31 / A35 Bere Regis Roundabout is not in the modelled area. However, a worst case assumption would be to assume all traffic using Zones 205 and 206 attached to the A35 and Zone 207 attached to the C80 would travel through the junction.

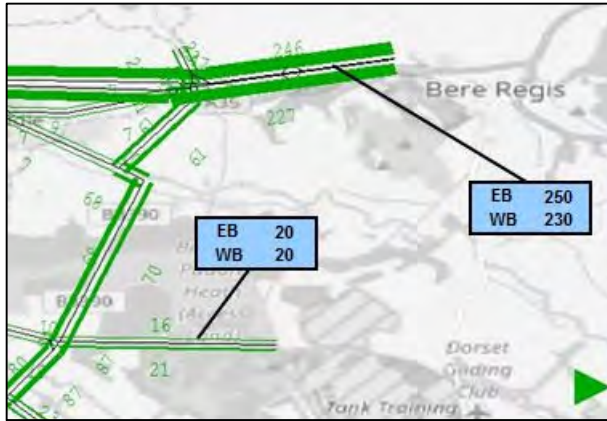

**Figure 5.34 – Scenario SC5 2031 vs. Base 2016 Inter Peak**

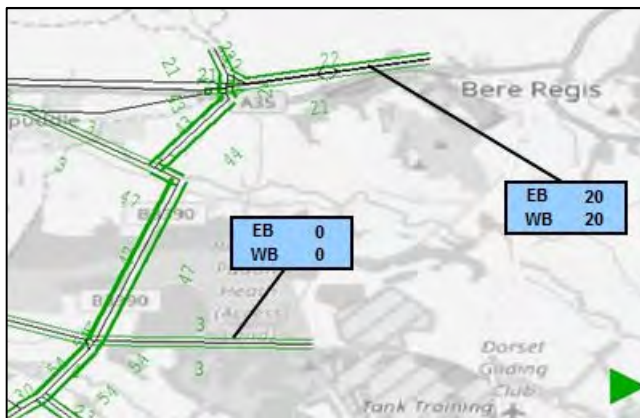

**Figure 5.35 - Scenario SC5 2031 vs. Scenario SC0 2031 Inter Peak**

5.47 Looking at the modelled flows on the links mentioned above, the increases in traffic would be 520 PCUs by 2031 with just background growth. The proposed ‘worst case’ Scenario SC5 would add an additional 40 PCUs per hour in the inter-peak period.

## 6.0 CONCLUSIONS

- 6.1 Existing traffic levels have been established on the B3390 and surrounding area. New traffic count data was collected at twenty locations. (Para 2.1)
- 6.2 Traffic on the B3390 north of Crossways reduced by around 20 percent between 2007 and 2014, reducing from 5,300 to 4,100 vehicles per day. (Para 2.4)
- 6.3 Traffic on the A35 Trunk Road, west of Puddletown has increased by around 8 percent between 2005 and 2014, increasing from 27,100 to 29,200 vehicles per day. (Para 2.5)
- 6.4 An inter-peak SATURN traffic model was created and calibrated to appropriate standards adequately reflecting current traffic flows. (Chapter 3)
- 6.5 Forecast increases in traffic were calculated using data from a number of sources; NTM TEMPRO database, TRICS database and existing Transport Assessments. (Chapter 4)
- 6.6 The 'Core' 2031 forecast scenario contains 21.1% more trips than the base 2016 year and excludes the proposed local development growth in the Crossways area. The worst case SC5 scenario contains 44.4% more trips than the base. (Para 4.5)
- 6.7 All inter-peak forecast models performed well and showed no signs of excessive queuing or deterioration of vehicle speeds (increasing congestion) in any scenario. (Table 5.1)
- 6.8 The figures provided for quarry related HGV traffic show there will be fewer lorry movements with only two quarries open simultaneously instead of three. (Para 5.14)
- 6.9 In the worst case SC5 development scenario (2800 dwellings), significant increases in traffic are noted on the B3390 south of Crossways and the C33 West Stafford Bypass. However, the highest predicted future flows on these roads are around 550 PCUs per hour which should be comfortably accommodated in terms of capacity. (Figure 5.15)
- 6.10 All scenarios exhibited increases in traffic could cause some additional queuing at the Moreton and Woodsford No. 38 Level Crossings (Paras 5.23 and 5.25)
- 6.11 The proposed developments in the worst case scenario SC5 has some effect on the key junctions however, the modelled volume over capacity figures show each junction can cope with the predicted inter-peak traffic. (Para 5.32 to Para 5.45).

# **APPENDIX A**

## **Model Zone List**

## MODEL ZONE LIST

Zone	Level	Name
1	Crossways C - Bingham Rd	West Dorset
2	Crossways C - Green Ln	West Dorset
3	Crossways C - Warmwell Rd NE	West Dorset
4	Crossways C - Crossways Ct	West Dorset
5	Crossways C - Heathland Cl	West Dorset
6	Crossways C - Old Farm Way	West Dorset
7	Crossways C - Coombe Way and Hope Cl	West Dorset
8	Crossways C - Airfield and Empool Cl	West Dorset
9	Crossways C - Spitfire Cl	West Dorset
10	Crossways C - The Scotton Way	West Dorset
11	Crossways C - Hurricane Cl	West Dorset
12	Crossways C - Moynton Cl	West Dorset
13	Crossways C - Pauls Way	West Dorset
14	Crossways C - Briars End	West Dorset
15	Crossways C - Dick O'Th'Banks Rd	West Dorset
16	Crossways C - Egdon Glen	West Dorset
17	Warmwell quarry: west of Crossways	West Dorset
18	Warmwell N: incl. Warmwell Leisure	West Dorset
19	Crossways C - Mount Skippet Way	West Dorset
20	Crossways NW	West Dorset
21	Crossways N - Woodsford Rd	West Dorset
22	Crossways NE	Purbeck
23	Crossways E	Purbeck
24	Moreton Pit	Purbeck
25	Moreton Station	Purbeck
26	Owermoigne outer E	West Dorset
27	Owermoigne outer W	West Dorset
28	Warmwell E	West Dorset
29	Warmwell W	West Dorset
30	Fryer Mayne	West Dorset
31	Warmwell village	West Dorset
32	West Knighton outer W	West Dorset
33	West Knighton outer N	West Dorset
34	West Knighton S	West Dorset
35	West Knighton N	West Dorset
36	West Knighton C	West Dorset
37	Broadmayne NW	West Dorset
38	Broadmayne NE	West Dorset
39	Broadmayne C	West Dorset
40	Broadmayne S	West Dorset
41	Broadmayne SE	West Dorset
44	Owermoigne C	West Dorset
45	Moreton and Hurst	Purbeck
48	Owermoigne S	West Dorset
49	West Stafford S	West Dorset
50	West Stafford N	West Dorset
51	West Stafford S and surrounding	West Dorset
52	West Stafford N and surrounding	West Dorset
53	West Knighton N and surrounding	West Dorset
54	Woodsford	West Dorset
61	Dorchester S: roads south of the station between Weymouth Ave and B3144	West Dorset 010
62	Puddletown ward: incl. Stinsford, Athelhampton, Tincleton, Tolpuddle, and Burleston	West Dorset
77	Chaldon Herring	Purbeck

80	Gillingham: north of A30 up to Dorset's north border	West Dorset
101	Spare zone for proposed development	
102	Spare zone for proposed development	
103	Proposed Station Rd Quarry	Purbeck
104	Proposed Hurst Farm Quarry	Purbeck
105	Spare zone for proposed development	
201	A35 SW of A352	SW
202	B3144 Dorchester	West Dorset 010
203	B3150 Dorchester	West Dorset 009
204	A354 Blandford	West Dorset
205	A35 Bere Regis EB	Dorset
206	A35 Bere Regis WB	Dorset
207	C80 Clouds Hill	Purbeck
208	Chalky Road, Weymouth	Weymouth and Portland
209	South of Moreton	Purbeck
210	A352 Wool	Purbeck
211	A353 Weymouth	Weymouth and Portland



# **APPENDIX B**

## **Model Calibration Results**

CALIBRATION RESULTS - INTERPEAK

Road	Location	Count	Direction	Date	Node A	Node B	Observed				Modelled				Dif.(%)	Dif. (Abs.)	GEH
							Car	LGV	OGV	Obs. Total	Car	LGV	OGV	Asgn. Total			
A352	Owermoigne	10	EB	2016-05-23 to 2016-05-29	829	836	297	39	27	363	234	65	57	355	-2.2%	-8	0.42
A352	Owermoigne	10	WB	2016-05-23 to 2016-05-29	836	829	293	50	29	372	318	69	39	425	14.3%	53	2.66
A352	Came	317	NWB	2016-04-18 to 2016-04-24	697	823	183	35	19	237	194	9	41	244	2.9%	7	0.44
A352	Came	317	SEB	2016-04-18 to 2016-04-24	823	697	181	31	20	232	115	22	47	184	-20.8%	-48	3.35
B3390	Crossways	355	NWB	2016-05-17 to 2016-05-23	402	865	106	27	23	156	93	26	28	147	-5.5%	-9	0.70
B3390	Crossways	355	SEB	2016-05-17 to 2016-05-23	865	402	112	31	23	166	126	25	29	180	8.7%	14	1.09
C80	C80 East of B3390, Waddock Cross	1394	EB	2010-05-13 to 2010-05-19	401	442	72	20	11	103	62	11	13	86	-16.7%	-17	1.77
C80	C80 East of B3390, Waddock Cross	1394	WB	2010-05-13 to 2010-05-19	442	401	91	23	14	128	90	12	18	120	-6.3%	-8	0.72
C33	West Stafford Bypass	1395	EB	2014-03-17 to 2014-03-30	825	605	140	19	29	188	118	14	34	165	-12.0%	-23	1.70
C33	West Stafford Bypass	1395	WB	2014-03-17 to 2014-03-30	605	825	120	18	30	168	102	13	29	144	-14.0%	-24	1.88
D21322	West of Crossways	1450	EB	2016-05-17 to 2016-05-23	856	866	126	35	33	194	105	11	30	145	-25.0%	-49	3.72
D21322	West of Crossways	1450	WB	2016-05-17 to 2016-05-23	866	856	105	31	33	169	76	12	27	115	-31.8%	-54	4.50
B3390	Warmwell Rd, Crossways	1451	NEB	2016-05-17 to 2016-05-23	922	832	74	22	20	116	89	20	16	126	8.4%	10	0.89
B3390	Warmwell Rd, Crossways	1451	SWB	2016-05-17 to 2016-05-23	832	922	88	26	21	135	77	18	14	109	-19.2%	-26	2.34
C33	East of West Stafford	1634	EB	2016-05-17 to 2016-05-23	710	441	113	35	30	178	123	14	34	170	-4.3%	-8	0.57
C33	East of West Stafford	1634	WB	2016-05-17 to 2016-05-23	441	710	119	38	40	197	108	15	29	153	-22.5%	-44	3.35
D21324	Higher Woodsford	1636	NB	2013-03-07 to 2013-03-13	834	641	7	2	0	9	15	5	0	20	117.7%	11	2.80
D21324	Higher Woodsford	1636	SB	2013-03-07 to 2013-03-13	641	834	8	2	0	10	9	1	1	12	16.5%	2	0.50
A35	Yellowham Hill	2004	EB	7-20 March 2016	634	665	770	138	107	1015	749	153	169	1072	5.6%	57	1.75
A35	Yellowham Hill	2004	WB	7-20 March 2016	666	635	815	124	112	1051	703	143	165	1012	-3.7%	-39	1.21
A35	Rogers Hill Farm	2005	EB	May 2016	687	688	651	117	161	929	706	142	152	999	7.5%	70	2.26
A35	Rogers Hill Farm	2005	WB	May 2016	692	684	542	163	250	955	729	103	139	971	1.6%	16	0.50
B3390	Warmwell Rd, Crossways	2054	NEB	2016-05-17 to 2016-05-23	830	907	98	28	37	163	84	19	34	136	-16.3%	-27	2.17
B3390	Warmwell Rd, Crossways	2054	SWB	2016-05-17 to 2016-05-23	907	830	95	32	37	164	79	20	38	137	-16.5%	-27	2.21
B3390	Warmwell Road, Crossways	2137	NEB	2016-05-18 to 2016-05-24	827	922	92	16	14	122	97	20	23	141	15.5%	19	1.65
B3390	Warmwell Road, Crossways	2137	SWB	2016-05-18 to 2016-05-24	922	827	96	15	12	123	83	18	38	139	13.3%	16	1.42
A35	E OF A354 NORTHBROOK INTERCHANG	2464	EB	May 2016	673	687	678	127	70	875	610	121	137	869	-0.7%	-6	0.22
A35	E OF A354 NORTHBROOK INTERCHANG	2464	WB	May 2016	684	674	678	122	62	862	644	80	126	849	-1.5%	-13	0.44
A352	Broadmayne	2596	NWB	2014-11-29 to 2014-12-05	950	820	138	26	16	180	164	13	42	219	21.9%	39	2.79
A352	Broadmayne	2596	SEB	2014-11-29 to 2014-12-05	820	950	146	25	16	187	130	23	51	205	9.4%	18	1.26
A352	South of Whitcombe	2965	NWB	2016-04-18 to 2016-04-24	819	697	169	33	19	221	194	9	41	244	10.3%	23	1.49
A352	South of Whitcombe	2965	SEB	2016-04-18 to 2016-04-24	697	819	166	29	20	215	115	22	51	188	-12.5%	-27	1.89
D21322	West Link Rd, Crossways	3018	NB	2016-05-17 to 2016-05-23	909	911	63	21	29	113	55	13	28	96	-15.4%	-17	1.71
D21322	West Link Rd, Crossways	3018	SB	2016-05-17 to 2016-05-23	911	909	73	19	25	117	45	11	25	81	-30.9%	-36	3.63

# **APPENDIX C**

## **Model Validation Results**

VALIDATION RESULTS - INTER PEAK

Site no.	Road	Location	Dir.	Date	Node A	Node B	Node C	Observed				Modelled				Dif.(%)	Dif. (Abs.)	GEH
								Car	LGV	OGV	Total	Car	LGV	OGV	Total			
5138-0411	A35 (T)	Bere Regis Rd	L	4-Oct-11	800	205	841	6	1	0	7	0	0	0	0	-100.0%	-7	3.70
5138-0411	A35 (T)	Bere Regis Rd	S/O	4-Oct-11	800	205	842	399	89	89	577	467	77	118	662	14.8%	85	3.42
5138-0411	A35 (T)	Bere Regis Rd	R	4-Oct-11	800	205	843	266	47	15	327	235	67	47	349	6.6%	22	1.18
5138-0411	C80	Hollow Hill	L	4-Oct-11	841	205	842	24	4	1	30	0	0	0	0	-100.0%	-30	7.74
5138-0411	C80	Hollow Hill	S/O	4-Oct-11	841	205	843	42	7	1	50	28	2	0	30	-40.0%	-20	3.15
5138-0411	C80	Hollow Hill	R	4-Oct-11	841	205	800	6	2	1	8	2	0	0	2	-74.3%	-6	2.62
5138-0411	A35 (T)	Dorchester Bypass	L	4-Oct-11	842	205	843	23	5	5	33	0	0	1	1	-97.7%	-32	7.85
5138-0411	A35 (T)	Dorchester Bypass	S/O	4-Oct-11	842	205	800	404	94	91	590	445	107	110	662	12.3%	73	2.91
5138-0411	A35 (T)	Dorchester Bypass	R	4-Oct-11	842	205	841	19	3	1	23	0	0	0	0	-100.0%	-23	6.77
5138-0411	B3150	Stinsford Hill	L	4-Oct-11	843	205	800	270	54	15	339	301	45	59	405	19.5%	66	3.43
5138-0411	B3150	Stinsford Hill	S/O	4-Oct-11	843	205	841	43	4	2	49	27	2	0	29	-40.2%	-20	3.15
5138-0411	B3150	Stinsford Hill	R	4-Oct-11	843	205	842	34	3	7	43	0	0	8	8	-80.6%	-35	6.86
	A35 (T)	Bere Regis Rd	NEB	4-Oct-11	205	800		681	150	106	937	748	153	169	1070	14.2%	133	4.20
	A35 (T)	Bere Regis Rd	SWB	4-Oct-11	800	205		671	136	104	911	703	143	165	1011	11.0%	100	3.23
	C80	Hollow Hill	EB	4-Oct-11	841	205		72	13	3	79	27	2	0	29	-62.7%	-49	6.73
	C80	Hollow Hill	WB	4-Oct-11	205	841		68	8	3	88	30	2	0	32	-63.6%	-56	7.20
	A35 (T)	Dorchester Bypass	NB	4-Oct-11	842	205		447	102	97	646	445	107	111	663	2.7%	17	0.68
	A35 (T)	Dorchester Bypass	SB	4-Oct-11	205	842		457	96	97	650	467	77	126	671	3.1%	20	0.79
	B3150	Stinsford Hill	EB	4-Oct-11	843	205		347	62	23	432	329	47	67	443	2.7%	12	0.55
	B3150	Stinsford Hill	WB	4-Oct-11	205	843		331	59	21	410	264	68	48	380	-7.5%	-31	1.54
5138-0311	A35 (T)	Dorchester Bypass (North)	L	4-Oct-11	956	603	846	29	7	12	47	35	0	14	49	3.3%	2	0.22
5138-0311	A35 (T)	Dorchester Bypass (North)	S/O	4-Oct-11	956	603	815	427	89	86	602	433	77	112	622	3.2%	19	0.78
5138-0311	A352	Wareham Rd	L	4-Oct-11	846	603	815	129	26	45	200	123	9	67	199	-0.5%	-1	0.07
5138-0311	A352	Wareham Rd	R	4-Oct-11	846	603	956	9	4	4	16	0	0	0	0	-100.0%	-16	5.74
5138-0311	A35 (T)	Dorchester Bypass (South)	S/O	4-Oct-11	815	603	956	440	97	94	632	445	107	111	663	5.0%	32	1.24
5138-0311	A35 (T)	Dorchester Bypass (South)	R	4-Oct-11	815	603	846	162	21	37	219	63	22	65	149	-32.0%	-70	5.18
	A35 (T)	Dorchester Bypass (North)	NEB	4-Oct-11	603	956		449	101	98	648	445	107	111	663	2.3%	15	0.59
	A35 (T)	Dorchester Bypass (North)	SWB	4-Oct-11	956	603		456	96	98	650	467	77	126	671	3.2%	21	0.81
	A352	Wareham Rd	NEB	4-Oct-11	603	846		190	28	49	267	97	22	79	198	-25.8%	-69	4.51
	A352	Wareham Rd	SWB	4-Oct-11	846	603		138	30	49	217	123	9	67	199	-8.0%	-17	1.20
	A35 (T)	Dorchester Bypass (South)	SWB	4-Oct-11	603	815		556	115	131	803	556	86	179	821	2.3%	18	0.64
	A35 (T)	Dorchester Bypass (South)	NEB	4-Oct-11	815	603		602	118	131	851	507	129	176	812	-4.6%	-39	1.34
50156	B3390	Warmwell Rd NE	1 to 2	19-May-16	865	402	918	4	1	5	9	1	0	5	6	-32.2%	-3	1.08
50156	B3390	Warmwell Rd NE	1 to 3	19-May-16	865	402	695	79	22	20	121	100	20	24	144	19.2%	23	2.01
50156	B3390	Warmwell Rd NE	1 to 4	19-May-16	865	402	905	22	7	0	29	28	6	0	33	13.3%	4	0.70
50156	D51811	Redbridge Rd	2 to 3	19-May-16	918	402	695	9	5	9	23	1	0	11	12	-49.4%	-12	2.76
50156	D51811	Redbridge Rd	2 to 4	19-May-16	918	402	905	8	2	1	11	3	1	0	4	-66.7%	-7	2.71
50156	D51811	Redbridge Rd	2 to 1	19-May-16	918	402	865	3	2	5	10	0	0	6	6	-36.4%	-4	1.25
50156	B3390	Warmwell Rd SW	3 to 4	19-May-16	695	402	905	15	4	1	19	17	3	0	20	6.2%	1	0.27
50156	B3390	Warmwell Rd SW	3 to 1	19-May-16	695	402	865	79	19	18	116	75	24	22	121	4.3%	5	0.46
50156	B3390	Warmwell Rd SW	3 to 2	19-May-16	695	402	918	10	6	11	27	4	0	12	17	-38.2%	-10	2.20
50156	D51801	Dick O'Th' Banks Rd	4 to 1	19-May-16	905	402	865	26	6	1	33	22	2	0	25	-25.2%	-8	1.54
50156	D51801	Dick O'Th' Banks Rd	4 to 2	19-May-16	905	402	918	8	2	0	11	33	2	0	34	225.1%	24	5.00
50156	D51801	Dick O'Th' Banks Rd	4 to 3	19-May-16	905	402	695	8	2	1	10	11	2	0	12	19.8%	2	0.61
	B3390	Warmwell Rd NE	NEB	19-May-16	402	865		108	27	23	158	97	26	28	152	-4.3%	-7	0.55
	B3390	Warmwell Rd NE	SWB	19-May-16	865	402		105	29	25	159	129	25	29	184	15.1%	24	1.83
	D51811	Redbridge Rd	EB	19-May-16	402	918		22	9	15	47	38	2	18	57	22.1%	10	1.44
	D51811	Redbridge Rd	WB	19-May-16	918	402		20	10	14	44	3	1	17	22	-50.9%	-22	3.91
	B3390	Warmwell Rd SW	NEB	19-May-16	695	402		104	29	29	162	96	27	35	158	-2.5%	-4	0.32
	B3390	Warmwell Rd SW	SWB	19-May-16	402	695		96	28	30	154	111	21	35	168	8.8%	14	1.07
	D51801	Dick O'Th' Banks Rd	EB	19-May-16	905	402		43	10	1	54	66	6	0	71	32.5%	17	2.21
	D51801	Dick O'Th' Banks Rd	WB	19-May-16	402	905		46	13	1	60	48	9	0	57	-3.7%	-2	0.29
	B3390	Warmwell Rd NE	L	19-May-16	402	695	946	11	4	0	15	40	5	1	46	211.9%	32	5.70
	B3390	Warmwell Rd NE	S/O	19-May-16	402	695	907	85	25	29	139	71	17	34	122	-12.4%	-17	1.51
	C83	Moreton Rd	L	19-May-16	946	695	907	10	2	1	12	5	1	0	6	-48.6%	-6	1.94
	C83	Moreton Rd	R	19-May-16	946	695	402	11	4	2	17	23	10	1	34	101.5%	17	3.40
	B3390	Warmwell Rd SW	S/O	19-May-16	907	695	402	93	25	28	146	73	17	34	124	-15.2%	-22	1.91
	B3390	Warmwell Rd SW	R	19-May-16	907	695	946	9	3	2	14	2	1	0	3	-76.9%	-11	3.65
	B3390	Warmwell Rd NE	NEB	19-May-16	695	402		104	29	30	163	96	27	35	158	-3.1%	-5	0.40
	B3390	Warmwell Rd NE	SWB	19-May-16	402	695		96	28	30	154	111	21	35	168	9.3%	14	1.13
	C83	Moreton Rd	NB	19-May-16	946	695		21	6	3	29	42	6	1	50	71.1%	21	3.29
	C83	Moreton Rd	SB	19-May-16	695	946		20	6	2	29	28	11	1	40	40.3%	12	1.97
	B3390	Warmwell Rd SW	NEB	19-May-16	907	695		103	27	30	160	76	18	34	128	-20.1%	-32	2.68
	B3390	Warmwell Rd SW	SWB	19-May-16	695	907		95	27	30	151	75	18	34	127	-15.8%	-24	2.02
50157	B3390	Warmwell Rd NE	S/O	19-May-16	830	644	831	56	19	14	88	58	17	12	87	-1.4%	-1	0.13
50157	B3390	Warmwell Rd NE	R	19-May-16	830	644	909	35	12	23	70	25	3	27	55	-22.0%	-15	1.95
50157	B3390	Warmwell Rd SW	L	19-May-16	831	644	909	22	7	5	34	23	6	4	32	-6.3%	-2	0.37
50157	B3390	Warmwell Rd SW	S/O	19-May-16	831	644	830	56	16	15	87	63	15	11	90	2.7%	2	0.25
50157	D21331	West Link Rd	L	19-May-16	909	644	830	39	12	20	71	24	7	23	54	-24.1%	-17	2.17
50157	D21331	West Link Rd	R	19-May-16	909	644	831	23	5	5	33	19	2	2	24	-28.3%	-9	1.75
	B3390	Warmwell Rd NE	NEB	19-May-16	644	830												

Site no.	Road	Location	Dir.	Date	Node A	Node B	Node C	Observed				Modelled				Dif.(%)	Dif. (Abs.)	GEH
								Car	LGV	OGV	Total	Car	LGV	OGV	Total			
	D21331	West Link Rd	SB	19-May-16	642	913		71	18	24	113	46	11	30	87	-23.1%	-26	2.62
	D21322	Highgate Ln	NWB	19-May-16	642	866		91	27	28	146	91	14	28	132	-9.8%	-14	1.21
	D21322	Highgate Ln	SEB	19-May-16	866	642		100	28	25	154	117	12	30	160	4.1%	6	0.50
50167	C33	Lewell Lane	L	19-May-16	641	441	863	1	0	1	1	0	0	2	2	34.6%	0	0.34
50167	C33	Lewell Lane	R	19-May-16	641	441	710	10	3	1	14	33	3	3	39	176.8%	25	4.81
50167	D21322	Highgate Ln E	S/O	19-May-16	863	441	710	85	27	30	142	76	12	27	114	-19.4%	-28	2.43
50167	D21322	Highgate Ln E	R	19-May-16	863	441	641	1	0	0	1	0	0	0	0	-100.0%	-1	1.15
50167	C82	Highgate Ln W	L	19-May-16	710	441	641	8	3	2	12	18	3	4	25	105.1%	13	2.97
50167	C82	Highgate Ln W	S/O	19-May-16	710	441	863	94	29	25	148	105	11	30	145	-1.8%	-3	0.22
	C33	Lewell Lane	EB	19-May-16	441	641		9	3	2	13	18	3	4	25	94.4%	12	2.79
	C33	Lewell Lane	WB	19-May-16	641	441		10	3	2	15	33	3	4	40	165.8%	25	4.76
	D21322	Highgate Ln E	EB	19-May-16	441	863		94	29	26	149	105	11	32	147	-1.5%	-2	0.19
	D21322	Highgate Ln E	WB	19-May-16	863	441		86	27	30	142	76	12	27	114	-19.8%	-28	2.49
	C82	Highgate Ln W	EB	19-May-16	710	441		102	32	27	160	123	14	34	170	6.3%	10	0.78
	C82	Highgate Ln W	WB	19-May-16	441	710		95	30	31	156	108	15	29	153	-1.9%	-3	0.23
	B3390	Warmwell Rd	1 to 2	14-Jun-16	827	312	952	15	2	1	19	2	2	2	6	-67.5%	-13	3.59
	B3390	Warmwell Rd	1 to 3	14-Jun-16	827	312	828	52	8	6	66	68	13	12	93	40.2%	27	2.98
	B3390	Warmwell Rd	1 to 4	14-Jun-16	827	312	826	10	2	2	14	13	3	24	41	196.2%	27	5.16
	A352	Wareham Rd	2 to 3	14-Jun-16	952	312	828	169	25	11	205	158	56	20	233	13.9%	28	1.92
	A352	Wareham Rd	2 to 4	14-Jun-16	952	312	826	112	22	13	147	151	11	18	180	22.6%	33	2.60
	A352	Wareham Rd	2 to 1	14-Jun-16	952	312	827	7	2	3	12	8	2	1	11	-9.8%	-1	0.34
	A353	Poxwell	3 to 4	14-Jun-16	828	312	826	22	4	1	27	0	0	0	0	-100.0%	-27	7.38
	A353	Poxwell	3 to 1	14-Jun-16	828	312	827	55	9	6	69	83	19	12	114	64.8%	45	4.68
	A353	Poxwell	3 to 2	14-Jun-16	828	312	952	162	18	11	191	139	41	13	192	0.6%	1	0.09
	A352	Broadmayne	4 to 1	14-Jun-16	826	312	827	28	4	4	36	6	0	10	16	-54.3%	-19	3.79
	A352	Broadmayne	4 to 2	14-Jun-16	826	312	952	131	20	10	160	94	23	41	159	-0.6%	-1	0.07
	A352	Broadmayne	4 to 3	14-Jun-16	826	312	828	28	8	3	39	30	0	0	30	-23.0%	-9	1.52
	B3390	Warmwell Rd	NB	14-Jun-16	312	827		89	15	13	116	97	20	23	141	21.0%	24	2.15
	B3390	Warmwell Rd	SB	14-Jun-16	827	312		78	12	9	99	83	18	38	139	41.4%	41	3.74
	A352	Wareham Rd	EB	14-Jun-16	312	952		308	39	22	370	235	66	57	357	-3.3%	-12	0.65
	A352	Wareham Rd	WB	14-Jun-16	952	312		288	49	27	364	317	69	39	424	16.6%	61	3.05
	A353	Poxwell	NB	14-Jun-16	828	312		239	30	18	288	222	59	25	306	6.5%	19	1.09
	A353	Poxwell	SB	14-Jun-16	312	828		249	41	21	310	255	69	31	356	14.8%	46	2.52
	A352	Broadmayne	EB	14-Jun-16	826	312		186	31	17	234	130	23	51	205	-12.4%	-29	1.97
	A352	Broadmayne	WB	14-Jun-16	312	826		145	28	15	188	164	15	42	221	17.5%	33	2.30
50154	B3390	Waddock Drove	1 to 2	17-May-16	646	401	442	6	1	1	7	0	0	0	1	-92.6%	-6	3.34
50154	B3390	Waddock Drove	1 to 3	17-May-16	646	401	648	34	8	7	48	84	19	14	116	139.8%	68	7.46
50154	B3390	Waddock Drove	1 to 4	17-May-16	646	401	647	4	1	1	5	0	0	0	0	-93.1%	-4	2.74
50154	C80	Oakers Wood	2 to 3	17-May-16	442	401	648	53	14	9	75	62	8	18	88	17.6%	13	1.46
50154	C80	Oakers Wood	2 to 4	17-May-16	442	401	647	14	3	1	18	28	3	0	30	65.7%	12	2.44
50154	C80	Oakers Wood	2 to 1	17-May-16	442	401	646	4	2	1	7	0	1	0	1	-84.3%	-6	2.94
50154	B3390	Hurst Bridges	3 to 4	17-May-16	648	401	647	5	2	2	8	0	0	0	0	-97.1%	-8	3.93
50154	B3390	Hurst Bridges	3 to 1	17-May-16	648	401	646	37	11	7	56	73	20	16	109	93.8%	53	5.80
50154	B3390	Hurst Bridges	3 to 2	17-May-16	648	401	442	44	13	10	67	35	9	13	56	-15.9%	-11	1.35
50154	C80	Affpuddle/Pallington	4 to 1	17-May-16	647	401	646	2	1	0	4	0	0	0	0	-100.0%	-4	2.74
50154	C80	Affpuddle/Pallington	4 to 2	17-May-16	647	401	442	13	3	1	17	27	2	0	29	73.6%	12	2.57
50154	C80	Affpuddle/Pallington	4 to 3	17-May-16	647	401	648	8	3	4	15	0	0	0	0	-100.0%	-15	5.42
	B3390	Waddock Drove	NEB	17-May-16	401	646		44	14	9	67	73	21	16	110	64.3%	43	4.57
	B3390	Waddock Drove	SWB	17-May-16	646	401		43	9	8	60	84	19	14	117	94.7%	57	6.05
	C80	Oakers Wood	EB	17-May-16	401	442		63	17	11	91	62	11	13	86	-5.4%	-5	0.52
	C80	Oakers Wood	WB	17-May-16	442	401		72	18	11	101	90	12	18	120	19.3%	19	1.85
	B3390	Hurst Bridges	NEB	17-May-16	648	401		87	26	19	132	108	29	29	165	25.7%	34	2.78
	B3390	Hurst Bridges	SWB	17-May-16	401	648		95	24	19	138	145	27	32	205	47.9%	66	5.06
	C80	Affpuddle/Pallington	EB	17-May-16	647	401		24	7	4	35	27	2	0	29	-17.5%	-6	1.09
	C80	Affpuddle/Pallington	WB	17-May-16	401	647		23	5	3	31	28	3	0	31	-1.4%	0	0.08
50155	B3390	Hurst	1 to 2	24-May-16	929	650	652	5	0	0	5	0	0	0	0	-100.0%	-5	3.11
50155	B3390	Hurst	1 to 3	24-May-16	929	650	927	105	14	37	156	126	24	29	179	14.7%	23	1.77
50155	B3390	Hurst	1 to 4	24-May-16	929	650	640	2	0	0	3	18	3	24	24	858.8%	21	5.90
50155	C33	Station Rd E	2 to 3	24-May-16	652	650	927	10	1	1	12	1	0	0	1	-94.1%	-11	4.44
50155	C33	Station Rd E	2 to 4	24-May-16	652	650	640	4	0	0	4	13	0	0	13	204.6%	9	2.99
50155	C33	Station Rd E	2 to 1	24-May-16	652	650	929	2	0	0	3	0	0	0	0	-100.0%	-3	2.26
50155	B3390	Station Rd SW	3 to 4	24-May-16	927	650	640	3	0	0	3	0	0	3	3	4.1%	0	0.07
50155	B3390	Station Rd SW	3 to 1	24-May-16	927	650	929	95	11	30	136	89	25	25	139	2.0%	3	0.23
50155	B3390	Station Rd SW	3 to 2	24-May-16	927	650	652	10	2	1	13	0	0	0	0	-97.5%	-13	4.91
50155	C33	Hurst Heath	4 to 1	24-May-16	640	650	929	4	0	0	4	14	3	3	21	392.5%	16	4.65
50155	C33	Hurst Heath	4 to 2	24-May-16	640	650	652	4	0	0	4	0	0	0	0	-93.3%	-4	2.61
50155	C33	Hurst Heath	4 to 3	24-May-16	640	650	927	2	0	0	2	0	0	0	0	-100.0%	-2	2.16
	B3390	Hurst	NEB	24-May-16	650	929		101	12	31	143	103	28	29	160	11.6%	17	1.35
	B3390	Hurst	SWB	24-May-16	929	650		112	14	37	164	145	26	32	203	24.2%	40	2.92
	C33	Station Rd E	EB	24-May-16	650	652		19	2	1	22	0	0	0	1	-97.3%	-21	6.36
	C33	Station Rd E	WB	24-May-16	652	650		16	1	2	19	14	0	0	14	-25.6%	-5	1.19
	B3390	Station Rd SW	NEB	24-May-16	927	650		108	13	31	152	89	25	28	142	-6.4%	-10	0



Site no.	Road	Location	Dir.	Date	Node A	Node B	Node C	Observed				Modelled				Dif.(%)	Dif. (Abs.)	GEH
								Car	LGV	OGV	Total	Car	LGV	OGV	Total			
50159	D21322	Highgate Lane NW	3 to 2	24-May-16	856	866	867	0	0	9	10	3	0	9	12	29.7%	3	0.85
	D21322	Highgate Lane SE	NWB	24-May-16	642	866		90	24	25	139	91	14	28	132	-5.0%	-7	0.60
	D21322	Highgate Lane SE	SEB	24-May-16	866	642		113	22	21	156	117	12	30	160	2.1%	3	0.26
	U/C	Quarry Entrance	NB	24-May-16	867	866		1	2	16	19	15	2	19	36	87.4%	17	3.19
	U/C	Quarry Entrance	SB	24-May-16	866	867		1	1	19	21	18	2	19	38	81.8%	17	3.16
	D21322	Highgate Lane NW	NWB	24-May-16	866	856		90	23	24	136	76	12	27	115	-15.4%	-21	1.87
	D21322	Highgate Lane NW	SEB	24-May-16	856	866		112	21	23	156	105	11	30	145	-6.5%	-10	0.82
50161	D51811	Redbride Road W	1 to 2	24-May-16	402	918	919	0	3	17	20	4	0	18	22	11.8%	2	0.51
50161	U/C	Moreton Pit Entrance	2 to 3	24-May-16	919	918	651	0	1	0	1	1	1	0	2	251.0%	2	1.36
50161	U/C	Moreton Pit Entrance	2 to 1	24-May-16	919	918	402	1	2	19	22	3	1	17	22	-2.8%	-1	0.13
50161	D51811	Redbride Rd E	3 to 2	24-May-16	651	918	919	0	0	1	1	0	0	0	0	-64.6%	-1	0.79
	U/C	Moreton Pit Entrance	NB	24-May-16	918	919		0	3	18	21	4	0	18	22	8.1%	2	0.36
	U/C	Moreton Pit Entrance	SB	24-May-16	919	918		1	3	19	23	4	2	17	24	4.6%	1	0.22
5138-0211	A352	East	L	4-Oct-11	845	204	846	97	20	44	161	104	6	66	177	9.6%	15	1.19
5138-0211	A352	East	A	4-Oct-11	845	204	844	204	29	13	247	192	16	4	212	-14.2%	-35	2.31
5138-0211	A352	South	L	4-Oct-11	846	204	844	42	8	6	56	38	1	5	44	-22.6%	-13	1.80
5138-0211	A352	South	R	4-Oct-11	846	204	845	135	18	42	195	59	21	74	154	-20.9%	-41	3.08
5138-0211	B3144	B3144	A	4-Oct-11	844	204	845	165	31	8	204	174	14	6	195	-4.6%	-9	0.66
5138-0211	B3144	B3144	R	4-Oct-11	844	204	846	32	9	4	45	19	3	1	23	-49.7%	-22	3.85
	A352	East	EB	4-Oct-11	204	845		300	49	50	399	233	36	81	349	-12.6%	-50	2.59
	A352	East	WB	4-Oct-11	845	204		302	49	57	408	296	22	70	388	-4.8%	-20	0.98
	A352	South	NB	4-Oct-11	846	204		177	26	48	251	97	22	79	198	-21.2%	-53	3.56
	A352	South	SB	4-Oct-11	204	846		130	29	48	206	123	9	67	199	-3.4%	-7	0.49
	B3144	B3144	EB	4-Oct-11	844	204		197	41	12	249	193	17	7	217	-12.8%	-32	2.08
	B3144	B3144	WB	4-Oct-11	204	844		246	37	20	303	231	16	8	255	-15.7%	-48	2.85
Junction 3 West Stafford Bypass	C33	West Stafford Bypass	L	12-Mar-15	825	604	823	2	0	1	3	0	0	0	0	-100.0%	-3	2.62
Junction 3 West Stafford Bypass	C33	West Stafford Bypass	A	12-Mar-15	825	604	824	165	29	14	208	102	13	29	144	-30.4%	-63	4.77
Junction 3 West Stafford Bypass	A352	South	L	12-Mar-15	823	604	824	123	21	20	164	194	9	41	244	48.3%	79	5.56
Junction 3 West Stafford Bypass	A352	South	R	12-Mar-15	823	604	825	13	2	1	16	0	0	0	0	-100.0%	-16	5.62
Junction 3 West Stafford Bypass	A352	West	A	12-Mar-15	824	604	825	134	23	10	167	118	14	34	165	-0.9%	-1	0.11
Junction 3 West Stafford Bypass	A352	West	R	12-Mar-15	824	604	823	171	30	5	206	115	22	47	184	-10.8%	-22	1.60
	C33	West Stafford Bypass	EB	12-Mar-15	604	825		147	25	11	183	118	14	34	165	-9.4%	-17	1.31
	C33	West Stafford Bypass	WB	12-Mar-15	825	604		167	29	15	211	102	13	29	144	-31.6%	-67	5.00
	A352	South	NB	12-Mar-15	823	604		135	23	21	180	194	9	41	244	35.3%	64	4.37
	A352	South	SB	12-Mar-15	604	823		173	30	6	209	115	22	47	184	-12.3%	-26	1.84
	A352	West	NWB	12-Mar-15	604	824		287	50	35	372	296	22	70	388	4.4%	16	0.83
	A352	West	SEB	12-Mar-15	824	604		305	53	15	373	233	36	81	349	-6.4%	-24	1.25
Junction 8AC	B3390	North	L	12-Mar-15	965	686	687	1	0	0	1	0	0	0	0	-100.0%	-1	1.73
Junction 8AC	B3390	North	A	12-Mar-15	965	686	681	18	4	0	22	0	0	0	0	-100.0%	-22	6.58
Junction 8AC	A35	Eastbound Slips	L	12-Mar-15	687	686	681	26	5	0	31	0	0	0	0	-100.0%	-31	7.89
Junction 8AC	A35	Eastbound Slips	R	12-Mar-15	687	686	965	1	0	0	1	0	0	0	0	-100.0%	-1	1.61
Junction 8AC	B3390	South	A	12-Mar-15	681	686	965	19	4	0	23	0	0	0	0	-100.0%	-23	6.78
Junction 8AC	B3390	South	R	12-Mar-15	681	686	687	38	7	1	46	95	20	15	130	183.7%	84	8.99
	B3390	North	NB	12-Mar-15	686	965		20	4	0	24	0	0	0	0	-100.0%	-24	6.97
	B3390	North	SB	12-Mar-15	965	686		19	4	0	23	0	0	0	0	-100.0%	-23	6.81
	A35	Eastbound Slips	EB	12-Mar-15	686	687		39	8	1	47	95	20	15	130	174.8%	83	8.80
	A35	Eastbound Slips	WB	12-Mar-15	687	686		27	5	0	32	0	0	0	0	-100.0%	-32	8.05
	B3390	South	NB	12-Mar-15	681	686		57	11	1	69	95	20	15	130	89.1%	61	6.16
	B3390	South	SB	12-Mar-15	686	681		44	9	0	53	0	0	0	0	-100.0%	-53	10.27
Junction 8AC	B3390	North	A	12-Mar-15	686	681	682	27	5	0	32	0	0	0	41	28.3%	9	1.50
Junction 8AC	B3390	North	R	12-Mar-15	686	681	680	17	3	0	21	0	0	0	0	-100.0%	-21	6.45
Junction 8AC	B3390	South	L	12-Mar-15	682	681	680	22	4	0	26	0	0	0	0	-100.0%	-26	7.23
Junction 8AC	B3390	South	A	12-Mar-15	682	681	686	48	9	1	58	69	15	15	98	69.1%	40	4.55
Junction 8AC	B3390	Dorchester Road	L	12-Mar-15	680	681	686	22	4	1	27	27	5	0	32	18.0%	5	0.90
Junction 8AC	B3390	Dorchester Road	R	12-Mar-15	680	681	682	38	8	2	48	61	18	13	92	91.1%	44	5.22
	B3390	North	NB	12-Mar-15	681	686		70	14	2	85	95	20	15	130	52.9%	45	4.35
	B3390	North	SB	12-Mar-15	686	681		44	9	0	53	0	0	0	41	-22.3%	-12	1.72
	B3390	South	NB	12-Mar-15	682	681		70	14	1	84	69	15	15	98	16.8%	14	1.48
	B3390	South	SB	12-Mar-15	681	682		65	13	2	80	61	18	13	133	65.9%	53	5.11
	B3390	Dorchester Road	EB	12-Mar-15	680	681		60	12	3	75	87	23	13	123	64.7%	48	4.87
	B3390	Dorchester Road	WB	12-Mar-15	681	680		39	8	0	47	0	0	0	0	-100.0%	-47	9.69
Junction 8B	A35	Westbound Slips	L	12-Mar-15	684	680	681	47	9	3	60	61	18	13	92	53.6%	32	3.68
Junction 8B	A35	Westbound Slips	R	12-Mar-15	684	680	212	19	4	1	24	25	5	0	30	27.5%	6	1.25
Junction 8B	C34	Dorchester Rd East	A	12-Mar-15	681	680	212	17	3	0	20	0	0	0	0	-100.0%	-20	6.36
Junction 8B	C34	Dorchester Rd East	R	12-Mar-15	681	680	684	24	5	0	29	0	0	0	0	-100.0%	-29	7.64
Junction 8B	C34	Dorchester Rd West	L	12-Mar-15	212	680	684	1	0	0	1	0	0	0	0	-100.0%	-1	1.44
Junction 8B	C34	Dorchester Rd West	A	12-Mar-15	212	680	681	18	3	0	21	27	5	0	32	52.1%	11	2.13
	A35	Westbound Slips	NB	12-Mar-15	680	684		25	5	0	30	0	0	0	0	-100.0%	-30	7.77
	A35	Westbound Slips	SB	12-Mar-15	684	680		66	13	5	83	86	23	13	122	46.2%	38	3.80
	C34	Dorchester Rd East	EB	12-Mar-15	680	681		64	13	3	81	87	23	13	123	53.2%	43	4.25
	C34	Dorchester Rd East	WB	12-Mar-15	681	680		41	8	0	49	0	0	0	0	-100.0%	-49	9.94
	C34	Dorchester Rd West	EB	12-Mar-15	212	680		18	4	0	22	27	5	0	32	44.9%	10	1.91
	C34	Dorchester Rd West	WB	12-Mar-15	680	212		36	7	1	44	25	5	0	30			

# **APPENDIX D**

## **Growth Factors**

Zone	Description	2016-31-Origin-IP	2016-31-Dest-IP
1	Crossways C - Bingham Rd	1.209	1.208
2	Crossways C - Green Ln	1.209	1.208
3	Crossways C - Warmwell Rd NE	1.209	1.208
4	Crossways C - Crossways Ct	1.209	1.208
5	Crossways C - Heathland Cl	1.209	1.208
6	Crossways C - Old Farm Way	1.209	1.208
7	Crossways C - Coombe Way and Hope Cl	1.209	1.208
8	Crossways C - Airfield and Empool Cl	1.209	1.208
9	Crossways C - Spitfire Cl	1.209	1.208
10	Crossways C - The Scotton Way	1.209	1.208
11	Crossways C - Hurricane Cl	1.209	1.208
12	Crossways C - Moynton Cl	1.209	1.208
13	Crossways C - Pauls Way	1.209	1.208
14	Crossways C - Briars End	1.209	1.208
15	Crossways C - Dick O'Th'Banks Rd	1.209	1.208
16	Crossways C - Egdon Glen	1.209	1.208
17	Warmwell quarry: west of Crossways	1.209	1.208
18	Warmwell N: incl. Warmwell Leisure	1.209	1.208
19	Crossways C - Mount Skippet Way	1.209	1.208
20	Crossways NW	1.209	1.208
21	Crossways N - Woodsford Rd	1.209	1.208
22	Crossways NE	1.169	1.168
23	Crossways E	1.169	1.168
24	Moreton Pit	1.169	1.168
25	Moreton Station	1.169	1.168
26	Owermoigne outer E	1.209	1.208
27	Owermoigne outer W	1.209	1.208
28	Warmwell E	1.209	1.208
29	Warmwell W	1.209	1.208
30	Fryer Mayne	1.209	1.208
31	Warmwell village	1.209	1.208
32	West Knighton outer W	1.209	1.208
33	West Knighton outer N	1.209	1.208
34	West Knighton S	1.209	1.208
35	West Knighton N	1.209	1.208
36	West Knighton C	1.209	1.208
37	Broadmayne NW	1.209	1.208
38	Broadmayne NE	1.209	1.208
39	Broadmayne C	1.209	1.208
40	Broadmayne S	1.209	1.208
41	Broadmayne SE	1.209	1.208
44	Owermoigne C	1.209	1.208
45	Moreton and Hurst	1.169	1.168
48	Owermoigne S	1.209	1.208
49	West Stafford S	1.209	1.208
50	West Stafford N	1.209	1.208
51	West Stafford S and surrounding	1.209	1.208
52	West Stafford N and surrounding	1.209	1.208
53	West Knighton N and surrounding	1.209	1.208
54	Woodsford	1.209	1.208
61	Dorchester S: roads south of the station between Weymouth Ave and B3144	1.215	1.212
62	Puddletown ward: incl. Stinsford, Athelhampton, Tincleton, Tolpuddle, and Burleston	1.209	1.208
77	Chaldon Herring	1.169	1.168
80	Gillingham: north of A30 up to Dorset's north border	1.209	1.208
101	Spare zone for proposed development	1.060	1.060
102	Spare zone for proposed development	1.060	1.060
103	Proposed Station Rd Quarry	1.169	1.168
104	Proposed Hurst Farm Quarry	1.169	1.168
105	Spare zone for proposed development	1.060	1.060
201	A35 SW of A352	1.203	1.203
202	B3144 Dorchester	1.215	1.212
203	B3150 Dorchester	1.224	1.225

204	A354 Blandford	1.209	1.208
205	A35 Bere Regis EB	1.206	1.206
206	A35 Bere Regis WB	1.206	1.206
207	C80 Clouds Hill	1.169	1.168
208	Chalky Road, Weymouth	1.200	1.198
209	South of Moreton	1.169	1.168
210	A352 Wool	1.169	1.168
211	A353 Weymouth	1.200	1.198

# **APPENDIX E**

## **TRICS Output**



Calculation Reference: AUDIT-645801-160802-0849

TRIP RATE CALCULATION SELECTION PARAMETERS:

Land Use : 03 - RESIDENTIAL  
 Category : A - HOUSES PRIVATELY OWNED  
 MULTI-MODAL VEHICLES

Selected regions and areas:

04	EAST ANGLIA	
	SF SUFFOLK	1 days
05	EAST MIDLANDS	
	LN LINCOLNSHIRE	2 days
07	YORKSHIRE & NORTH LINCOLNSHIRE	
	NE NORTH EAST LINCOLNSHIRE	1 days
	NY NORTH YORKSHIRE	1 days
08	NORTH WEST	
	CH CHESHIRE	1 days
11	SCOTLAND	
	FI FIFE	1 days
	SR STIRLING	1 days

This section displays the number of survey days per TRICS® sub-region in the selected set

Filtering Stage 2 selection:

This data displays the chosen trip rate parameter and its selected range. Only sites that fall within the parameter range are included in the trip rate calculation.

Parameter: Number of dwellings  
 Actual Range: 101 to 432 (units: )  
 Range Selected by User: 100 to 700 (units: )

Public Transport Provision:

Selection by: Include all surveys

Date Range: 01/01/06 to 20/05/15

This data displays the range of survey dates selected. Only surveys that were conducted within this date range are included in the trip rate calculation.

Selected survey days:

Monday	5 days
Tuesday	2 days
Friday	1 days

This data displays the number of selected surveys by day of the week.

Selected survey types:

Manual count	8 days
Directional ATC Count	0 days

This data displays the number of manual classified surveys and the number of unclassified ATC surveys, the total adding up to the overall number of surveys in the selected set. Manual surveys are undertaken using staff, whilst ATC surveys are undertaken using machines.

Selected Locations:

Suburban Area (PPS6 Out of Centre)	4
Edge of Town	4

This data displays the number of surveys per main location category within the selected set. The main location categories consist of Free Standing, Edge of Town, Suburban Area, Neighbourhood Centre, Edge of Town Centre, Town Centre and Not Known.

Selected Location Sub Categories:

Residential Zone	5
Out of Town	1
No Sub Category	2

This data displays the number of surveys per location sub-category within the selected set. The location sub-categories consist of Commercial Zone, Industrial Zone, Development Zone, Residential Zone, Retail Zone, Built-Up Zone, Village, Out of Town, High Street and No Sub Category.

Filtering Stage 3 selection:

Use Class:

C3 8 days

This data displays the number of surveys per Use Class classification within the selected set. The Use Classes Order 2005 has been used for this purpose, which can be found within the Library module of TRICS®.

Population within 1 mile:

1,001 to 5,000	1 days
5,001 to 10,000	1 days
10,001 to 15,000	2 days
15,001 to 20,000	4 days

This data displays the number of selected surveys within stated 1-mile radii of population.

Population within 5 miles:

5,001 to 25,000	1 days
50,001 to 75,000	3 days
75,001 to 100,000	1 days
100,001 to 125,000	3 days

This data displays the number of selected surveys within stated 5-mile radii of population.

Car ownership within 5 miles:

0.6 to 1.0	3 days
1.1 to 1.5	5 days

This data displays the number of selected surveys within stated ranges of average cars owned per residential dwelling, within a radius of 5-miles of selected survey sites.

Travel Plan:

No 8 days

This data displays the number of surveys within the selected set that were undertaken at sites with Travel Plans in place, and the number of surveys that were undertaken at sites without Travel Plans.

LIST OF SITES relevant to selection parameters

1	CH-03-A-06 CREWE ROAD	SEMI -DET./BUNGALOWS		CESHIRE
	CREWE			
	Suburban Area (PPS6 Out of Centre)			
	No Sub Category			
	Total Number of dwellings:	129		
	Survey date: TUESDAY	14/10/08		Survey Type: MANUAL
2	FI-03-A-03 WOODMILL ROAD	MIXED HOUSES		FIFE
	DUNFERMLINE			
	Edge of Town			
	Residential Zone			
	Total Number of dwellings:	155		
	Survey date: MONDAY	30/04/07		Survey Type: MANUAL
3	LN-03-A-01 BRANT ROAD	MIXED HOUSES		LINCOLNSHIRE
	BRACEBRIDGE			
	LINCOLN			
	Edge of Town			
	Residential Zone			
	Total Number of dwellings:	150		
	Survey date: TUESDAY	15/05/07		Survey Type: MANUAL
4	LN-03-A-02 HYKEHAM ROAD	MIXED HOUSES		LINCOLNSHIRE
	LINCOLN			
	Suburban Area (PPS6 Out of Centre)			
	Residential Zone			
	Total Number of dwellings:	186		
	Survey date: MONDAY	14/05/07		Survey Type: MANUAL
5	NE-03-A-02 HANOVER WALK	SEMI DETACHED & DETACHED		NORTH EAST LINCOLNSHIRE
	SCUNTHORPE			
	Edge of Town			
	No Sub Category			
	Total Number of dwellings:	432		
	Survey date: MONDAY	12/05/14		Survey Type: MANUAL
6	NY-03-A-06 HORSEFAIR	BUNGALOWS & SEMI DET.		NORTH YORKSHIRE
	BOROUGHBRIDGE			
	Suburban Area (PPS6 Out of Centre)			
	Residential Zone			
	Total Number of dwellings:	115		
	Survey date: FRIDAY	14/10/11		Survey Type: MANUAL
7	SF-03-A-03 BARTON HILL	MIXED HOUSES		SUFFOLK
	FORNHAM ST MARTIN			
	BURY ST EDMUNDS			
	Edge of Town			
	Out of Town			
	Total Number of dwellings:	101		
	Survey date: MONDAY	15/05/06		Survey Type: MANUAL

LIST OF SITES relevant to selection parameters (Cont.)

8 SR-03-A-01 DETACHED STIRLING  
BENVIEW  
  
STIRLING  
Suburban Area (PPS6 Out of Centre)  
Residential Zone  
Total Number of dwellings: 115  
Survey date: MONDAY 23/04/07 Survey Type: MANUAL

This section provides a list of all survey sites and days in the selected set. For each individual survey site, it displays a unique site reference code and site address, the selected trip rate calculation parameter and its value, the day of the week and date of each survey, and whether the survey was a manual classified count or an ATC count.

MANUALLY DESELECTED SITES

Site Ref	Reason for Deselection
NE-03-A-03	not included in developers selections

TRIP RATE for Land Use 03 - RESIDENTIAL/A - HOUSES PRIVATELY OWNED  
 MULTI-MODAL VEHICLES  
 Calculation factor: 1 DWELLS  
 BOLD print indicates peak (busiest) period

Time Range	ARRIVALS			DEPARTURES			TOTALS		
	No. Days	Ave. DWELLS	Trip Rate	No. Days	Ave. DWELLS	Trip Rate	No. Days	Ave. DWELLS	Trip Rate
00:00 - 01:00									
01:00 - 02:00									
02:00 - 03:00									
03:00 - 04:00									
04:00 - 05:00									
05:00 - 06:00									
06:00 - 07:00									
07:00 - 08:00	8	173	0.069	8	173	0.258	8	173	0.327
08:00 - 09:00	8	173	0.130	8	173	0.430	8	173	0.560
09:00 - 10:00	8	173	0.166	8	173	0.203	8	173	0.369
10:00 - 11:00	8	173	0.147	8	173	0.178	8	173	0.325
11:00 - 12:00	8	173	0.155	8	173	0.142	8	173	0.297
12:00 - 13:00	8	173	0.195	8	173	0.181	8	173	0.376
13:00 - 14:00	8	173	0.179	8	173	0.169	8	173	0.348
14:00 - 15:00	8	173	0.182	8	173	0.195	8	173	0.377
15:00 - 16:00	8	173	0.275	8	173	0.204	8	173	0.479
16:00 - 17:00	8	173	0.341	8	173	0.194	8	173	0.535
17:00 - 18:00	8	173	0.362	8	173	0.218	8	173	0.580
18:00 - 19:00	8	173	0.256	8	173	0.218	8	173	0.474
19:00 - 20:00									
20:00 - 21:00									
21:00 - 22:00									
22:00 - 23:00									
23:00 - 24:00									
<b>Total Rates:</b>			<b>2.457</b>			<b>2.590</b>			<b>5.047</b>

This section displays the trip rate results based on the selected set of surveys and the selected count type (shown just above the table). It is split by three main columns, representing arrivals trips, departures trips, and total trips (arrivals plus departures). Within each of these main columns are three sub-columns. These display the number of survey days where count data is included (per time period), the average value of the selected trip rate calculation parameter (per time period), and the trip rate result (per time period). Total trip rates (the sum of the column) are also displayed at the foot of the table.

To obtain a trip rate, the average (mean) trip rate parameter value (TRP) is first calculated for all selected survey days that have count data available for the stated time period. The average (mean) number of arrivals, departures or totals (whichever applies) is also calculated (COUNT) for all selected survey days that have count data available for the stated time period. Then, the average count is divided by the average trip rate parameter value, and multiplied by the stated calculation factor (shown just above the table and abbreviated here as FACT). So, the method is: COUNT/TRP\*FACT. Trip rates are then rounded to 3 decimal places.

Parameter summary

Trip rate parameter range selected: 101 - 432 (units: )  
 Survey date date range: 01/01/06 - 20/05/15  
 Number of weekdays (Monday-Friday): 8  
 Number of Saturdays: 0  
 Number of Sundays: 0  
 Surveys automatically removed from selection: 0  
 Surveys manually removed from selection: 1

This section displays a quick summary of some of the data filtering selections made by the TRICS® user. The trip rate calculation parameter range of all selected surveys is displayed first, followed by the range of minimum and maximum survey dates selected by the user. Then, the total number of selected weekdays and weekend days in the selected set of surveys are show. Finally, the number of survey days that have been manually removed from the selected set outside of the standard filtering procedure are displayed.



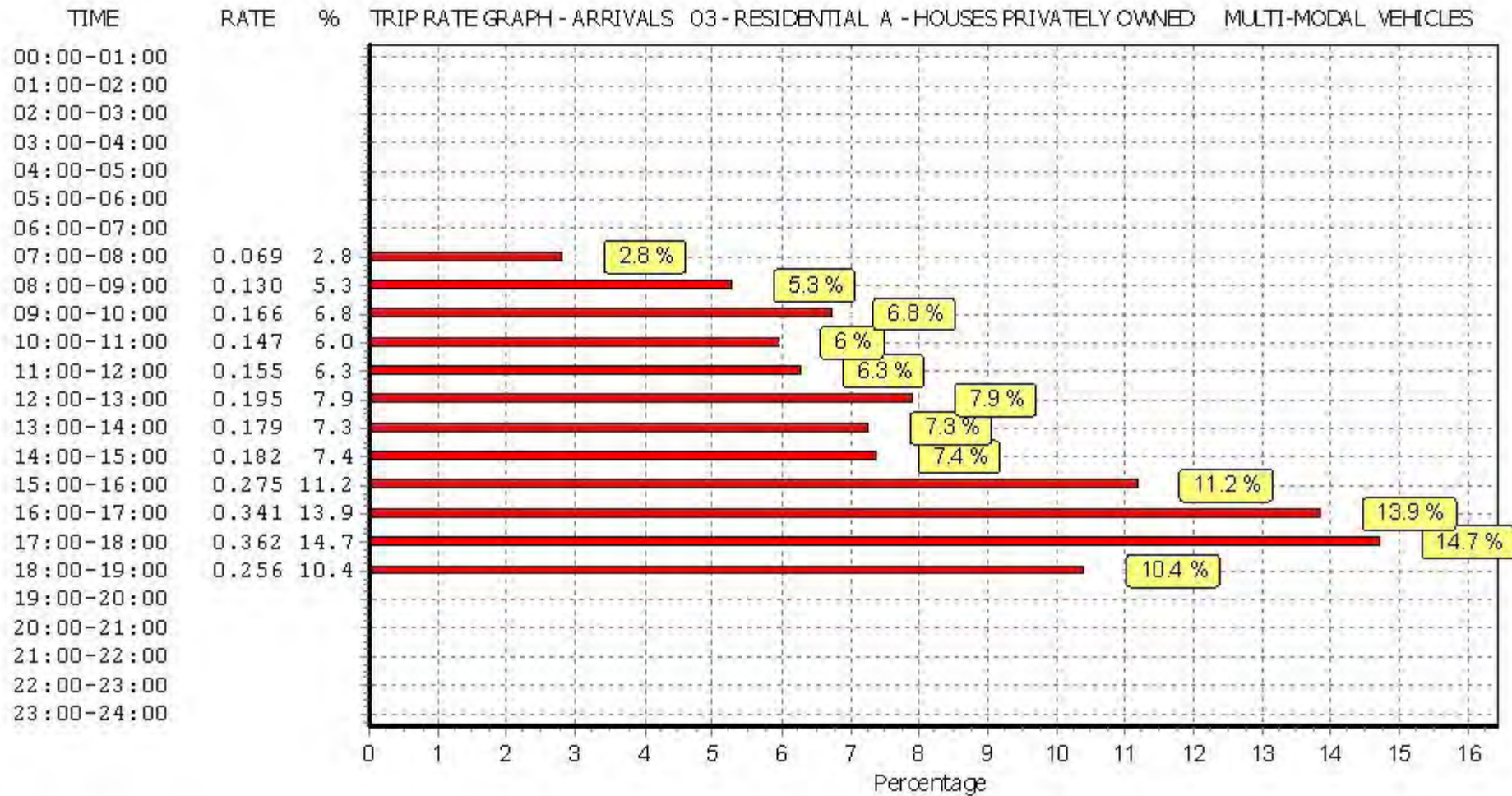

This graph is a visual representation of the trip rate calculation results screen. The same time periods and trip rates are displayed, but in addition there is an additional column showing the percentage of the total trip rate by individual time period, allowing peak periods to be easily identified through observation. Note that the type of count and the selected direction is shown at the top of the graph.

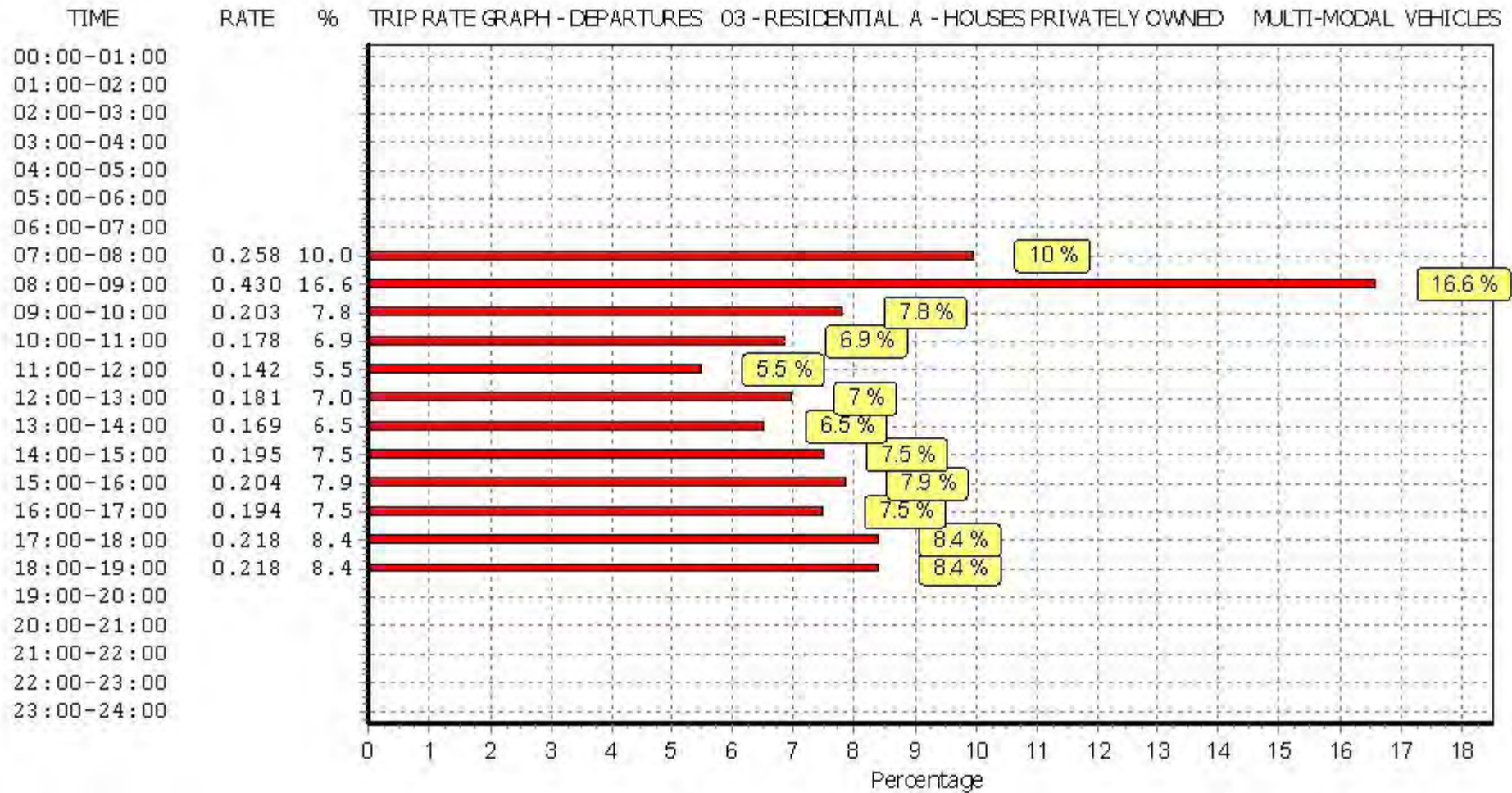

This graph is a visual representation of the trip rate calculation results screen. The same time periods and trip rates are displayed, but in addition there is an additional column showing the percentage of the total trip rate by individual time period, allowing peak periods to be easily identified through observation. Note that the type of count and the selected direction is shown at the top of the graph.



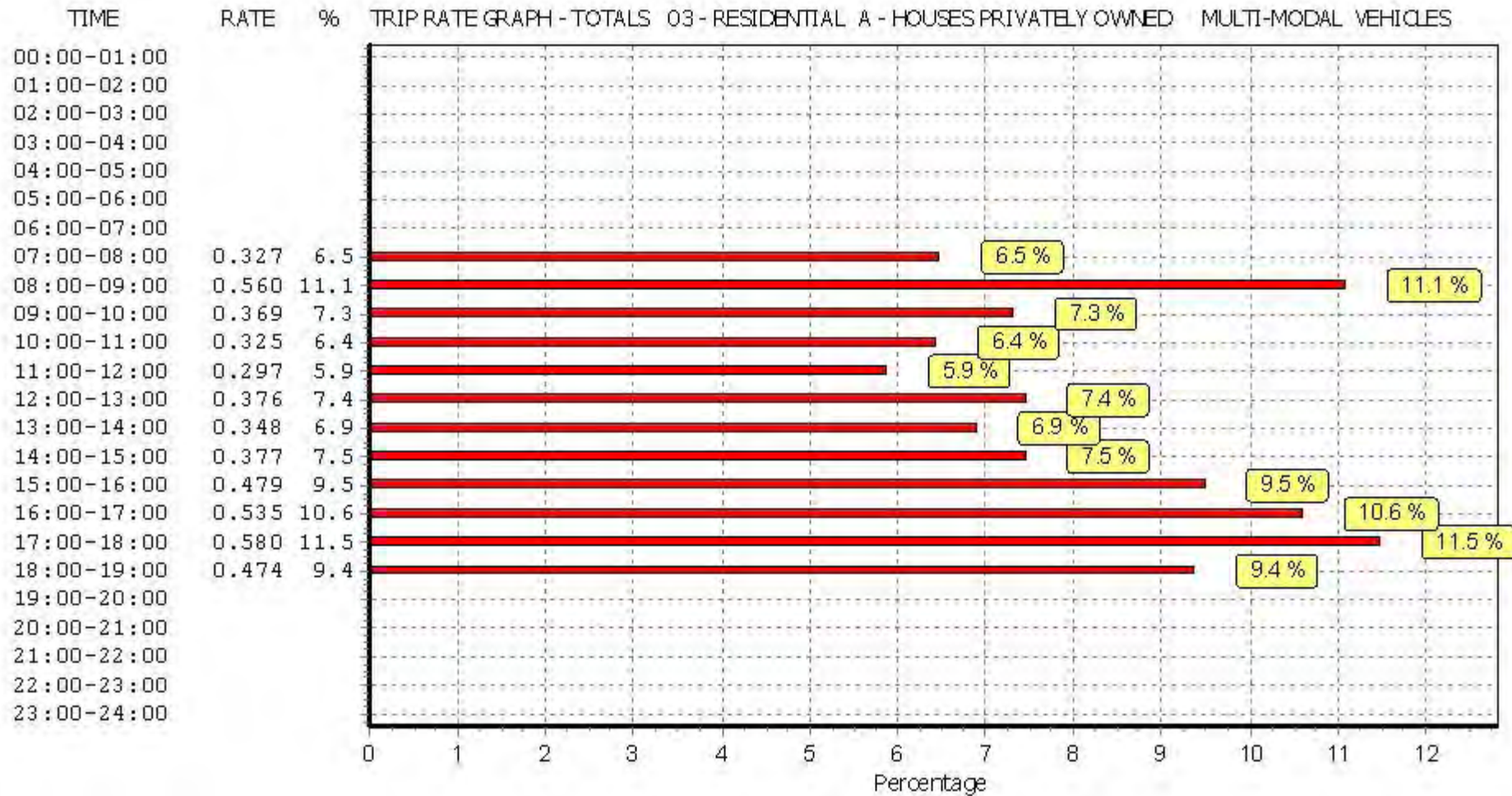

This graph is a visual representation of the trip rate calculation results screen. The same time periods and trip rates are displayed, but in addition there is an additional column showing the percentage of the total trip rate by individual time period, allowing peak periods to be easily identified through observation. Note that the type of count and the selected direction is shown at the top of the graph.

TRIP RATE for Land Use 03 - RESIDENTIAL/A - HOUSES PRIVATELY OWNED

MULTI-MODAL TAXIS

Calculation factor: 1 DWELLS

BOLD print indicates peak (busiest) period

Time Range	ARRIVALS			DEPARTURES			TOTALS		
	No. Days	Ave. DWELLS	Trip Rate	No. Days	Ave. DWELLS	Trip Rate	No. Days	Ave. DWELLS	Trip Rate
00:00 - 01:00									
01:00 - 02:00									
02:00 - 03:00									
03:00 - 04:00									
04:00 - 05:00									
05:00 - 06:00									
06:00 - 07:00									
07:00 - 08:00	8	173	0.001	8	173	0.001	8	173	0.002
08:00 - 09:00	8	173	0.000	8	173	0.000	8	173	0.000
09:00 - 10:00	8	173	0.001	8	173	0.001	8	173	0.002
10:00 - 11:00	8	173	0.002	8	173	0.002	8	173	0.004
11:00 - 12:00	8	173	0.000	8	173	0.000	8	173	0.000
12:00 - 13:00	8	173	0.001	8	173	0.001	8	173	0.002
13:00 - 14:00	8	173	0.000	8	173	0.000	8	173	0.000
14:00 - 15:00	8	173	0.002	8	173	0.001	8	173	0.003
15:00 - 16:00	8	173	0.001	8	173	0.003	8	173	0.004
16:00 - 17:00	8	173	0.001	8	173	0.001	8	173	0.002
17:00 - 18:00	8	173	0.001	8	173	0.001	8	173	0.002
18:00 - 19:00	8	173	0.001	8	173	0.001	8	173	0.002
19:00 - 20:00									
20:00 - 21:00									
21:00 - 22:00									
22:00 - 23:00									
23:00 - 24:00									
<b>Total Rates:</b>			0.011			0.012			0.023

This section displays the trip rate results based on the selected set of surveys and the selected count type (shown just above the table). It is split by three main columns, representing arrivals trips, departures trips, and total trips (arrivals plus departures). Within each of these main columns are three sub-columns. These display the number of survey days where count data is included (per time period), the average value of the selected trip rate calculation parameter (per time period), and the trip rate result (per time period). Total trip rates (the sum of the column) are also displayed at the foot of the table.

To obtain a trip rate, the average (mean) trip rate parameter value (TRP) is first calculated for all selected survey days that have count data available for the stated time period. The average (mean) number of arrivals, departures or totals (whichever applies) is also calculated (COUNT) for all selected survey days that have count data available for the stated time period. Then, the average count is divided by the average trip rate parameter value, and multiplied by the stated calculation factor (shown just above the table and abbreviated here as FACT). So, the method is: COUNT/TRP\*FACT. Trip rates are then rounded to 3 decimal places.

Parameter summary

Trip rate parameter range selected: 101 - 432 (units: )  
 Survey date date range: 01/01/06 - 20/05/15  
 Number of weekdays (Monday-Friday): 8  
 Number of Saturdays: 0  
 Number of Sundays: 0  
 Surveys automatically removed from selection: 0  
 Surveys manually removed from selection: 1

This section displays a quick summary of some of the data filtering selections made by the TRICS® user. The trip rate calculation parameter range of all selected surveys is displayed first, followed by the range of minimum and maximum survey dates selected by the user. Then, the total number of selected weekdays and weekend days in the selected set of surveys are show. Finally, the number of survey days that have been manually removed from the selected set outside of the standard filtering procedure are displayed.

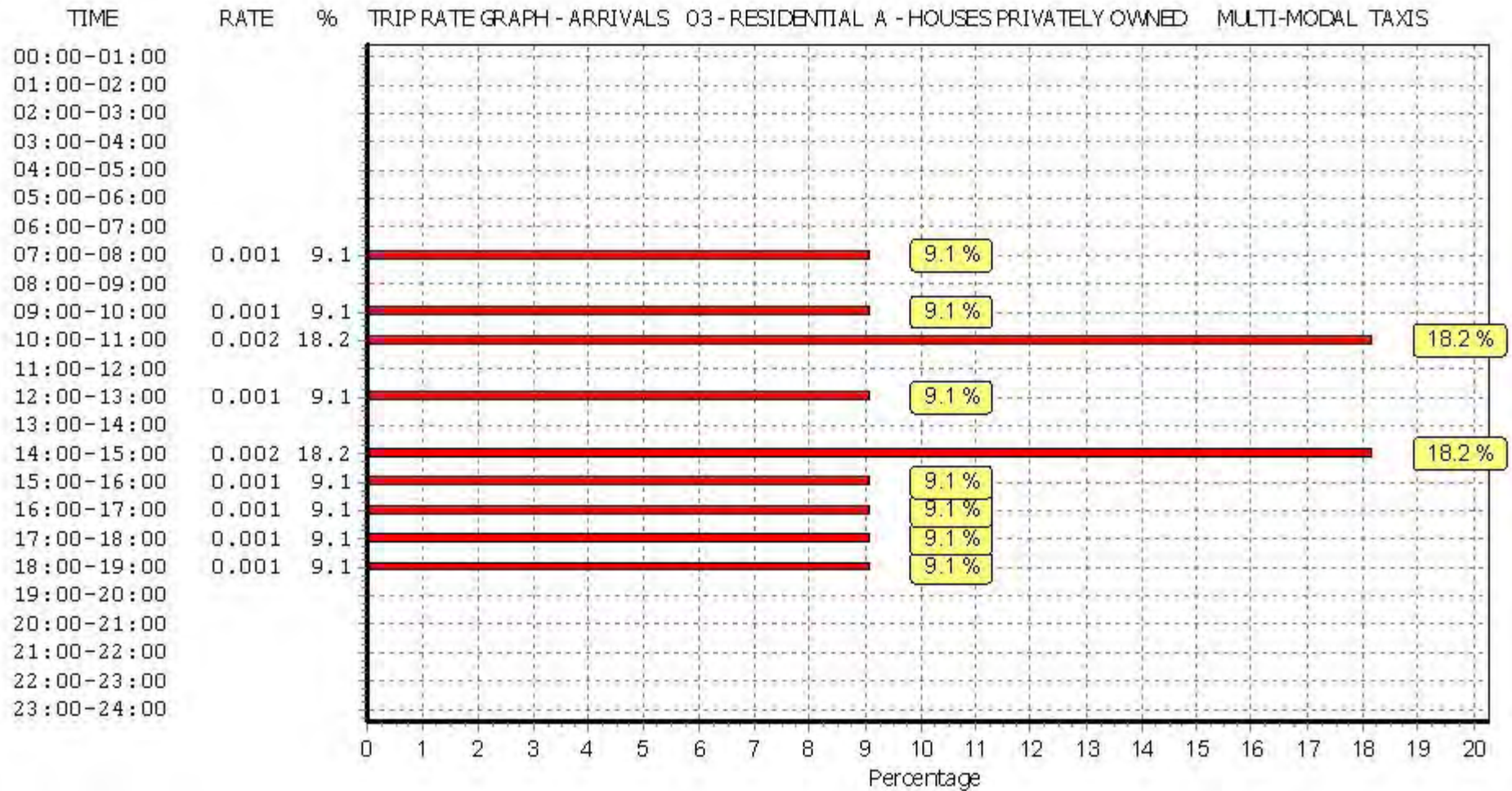

This graph is a visual representation of the trip rate calculation results screen. The same time periods and trip rates are displayed, but in addition there is an additional column showing the percentage of the total trip rate by individual time period, allowing peak periods to be easily identified through observation. Note that the type of count and the selected direction is shown at the top of the graph.



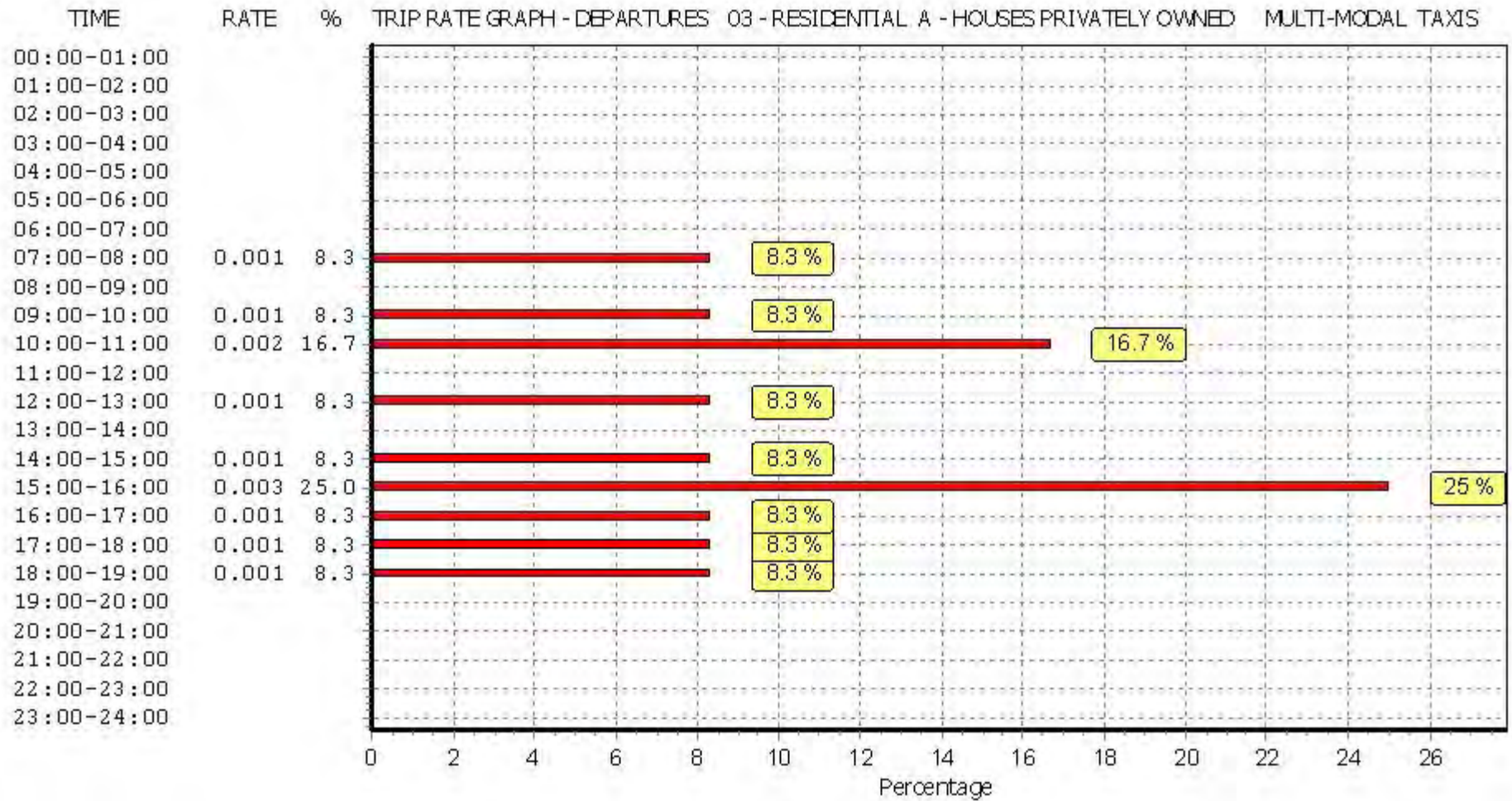

This graph is a visual representation of the trip rate calculation results screen. The same time periods and trip rates are displayed, but in addition there is an additional column showing the percentage of the total trip rate by individual time period, allowing peak periods to be easily identified through observation. Note that the type of count and the selected direction is shown at the top of the graph.



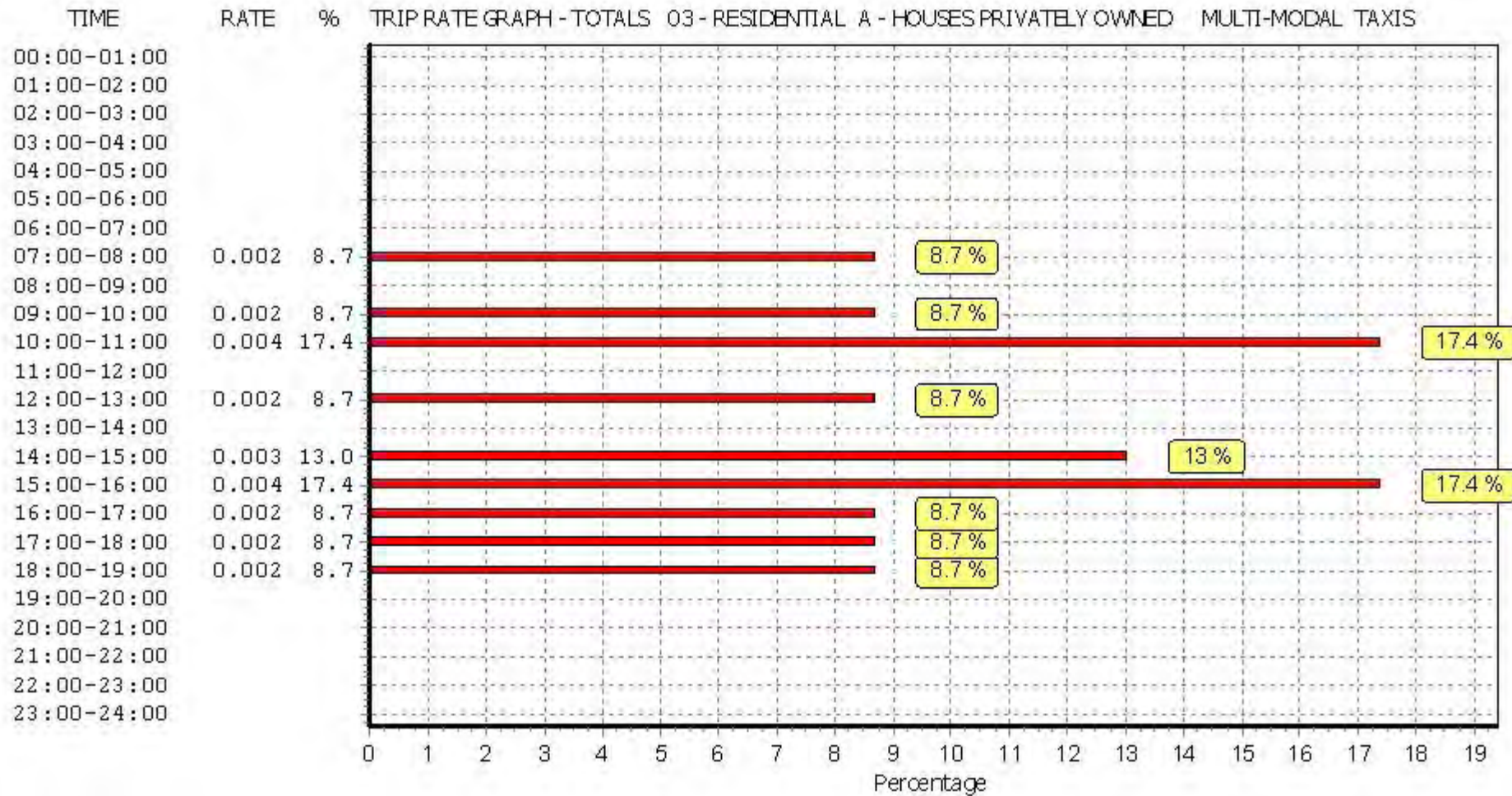

This graph is a visual representation of the trip rate calculation results screen. The same time periods and trip rates are displayed, but in addition there is an additional column showing the percentage of the total trip rate by individual time period, allowing peak periods to be easily identified through observation. Note that the type of count and the selected direction is shown at the top of the graph.

TRIP RATE for Land Use 03 - RESIDENTIAL/A - HOUSES PRIVATELY OWNED  
 MULTI-MODAL OGVS  
 Calculation factor: 1 DWELLS  
 BOLD print indicates peak (busiest) period

Time Range	ARRIVALS			DEPARTURES			TOTALS		
	No. Days	Ave. DWELLS	Trip Rate	No. Days	Ave. DWELLS	Trip Rate	No. Days	Ave. DWELLS	Trip Rate
00:00 - 01:00									
01:00 - 02:00									
02:00 - 03:00									
03:00 - 04:00									
04:00 - 05:00									
05:00 - 06:00									
06:00 - 07:00									
07:00 - 08:00	8	173	0.002	8	173	0.001	8	173	0.003
08:00 - 09:00	8	173	0.003	8	173	0.004	8	173	0.007
09:00 - 10:00	8	173	0.003	8	173	0.001	8	173	0.004
10:00 - 11:00	8	173	0.004	8	173	0.005	8	173	0.009
11:00 - 12:00	8	173	0.001	8	173	0.001	8	173	0.002
12:00 - 13:00	8	173	0.003	8	173	0.002	8	173	0.005
13:00 - 14:00	8	173	0.001	8	173	0.003	8	173	0.004
14:00 - 15:00	8	173	0.001	8	173	0.004	8	173	0.005
15:00 - 16:00	8	173	0.001	8	173	0.001	8	173	0.002
16:00 - 17:00	8	173	0.003	8	173	0.000	8	173	0.003
17:00 - 18:00	8	173	0.000	8	173	0.001	8	173	0.001
18:00 - 19:00	8	173	0.000	8	173	0.000	8	173	0.000
19:00 - 20:00									
20:00 - 21:00									
21:00 - 22:00									
22:00 - 23:00									
23:00 - 24:00									
<b>Total Rates:</b>			<b>0.022</b>			<b>0.023</b>			<b>0.045</b>

This section displays the trip rate results based on the selected set of surveys and the selected count type (shown just above the table). It is split by three main columns, representing arrivals trips, departures trips, and total trips (arrivals plus departures). Within each of these main columns are three sub-columns. These display the number of survey days where count data is included (per time period), the average value of the selected trip rate calculation parameter (per time period), and the trip rate result (per time period). Total trip rates (the sum of the column) are also displayed at the foot of the table.

To obtain a trip rate, the average (mean) trip rate parameter value (TRP) is first calculated for all selected survey days that have count data available for the stated time period. The average (mean) number of arrivals, departures or totals (whichever applies) is also calculated (COUNT) for all selected survey days that have count data available for the stated time period. Then, the average count is divided by the average trip rate parameter value, and multiplied by the stated calculation factor (shown just above the table and abbreviated here as FACT). So, the method is: COUNT/TRP\*FACT. Trip rates are then rounded to 3 decimal places.

Parameter summary

Trip rate parameter range selected: 101 - 432 (units: )  
 Survey date date range: 01/01/06 - 20/05/15  
 Number of weekdays (Monday-Friday): 8  
 Number of Saturdays: 0  
 Number of Sundays: 0  
 Surveys automatically removed from selection: 0  
 Surveys manually removed from selection: 1

This section displays a quick summary of some of the data filtering selections made by the TRICS® user. The trip rate calculation parameter range of all selected surveys is displayed first, followed by the range of minimum and maximum survey dates selected by the user. Then, the total number of selected weekdays and weekend days in the selected set of surveys are show. Finally, the number of survey days that have been manually removed from the selected set outside of the standard filtering procedure are displayed.

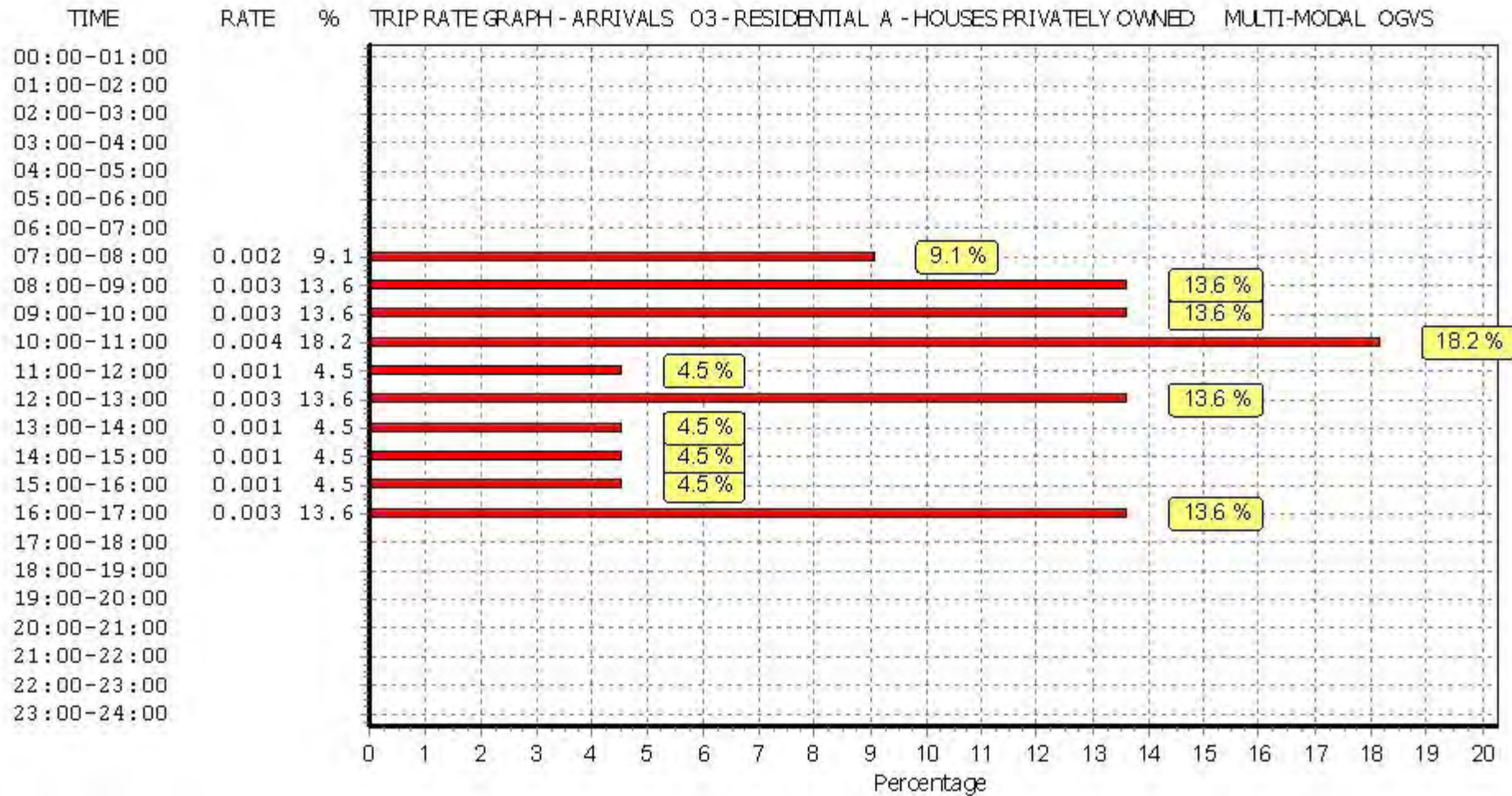

This graph is a visual representation of the trip rate calculation results screen. The same time periods and trip rates are displayed, but in addition there is an additional column showing the percentage of the total trip rate by individual time period, allowing peak periods to be easily identified through observation. Note that the type of count and the selected direction is shown at the top of the graph.



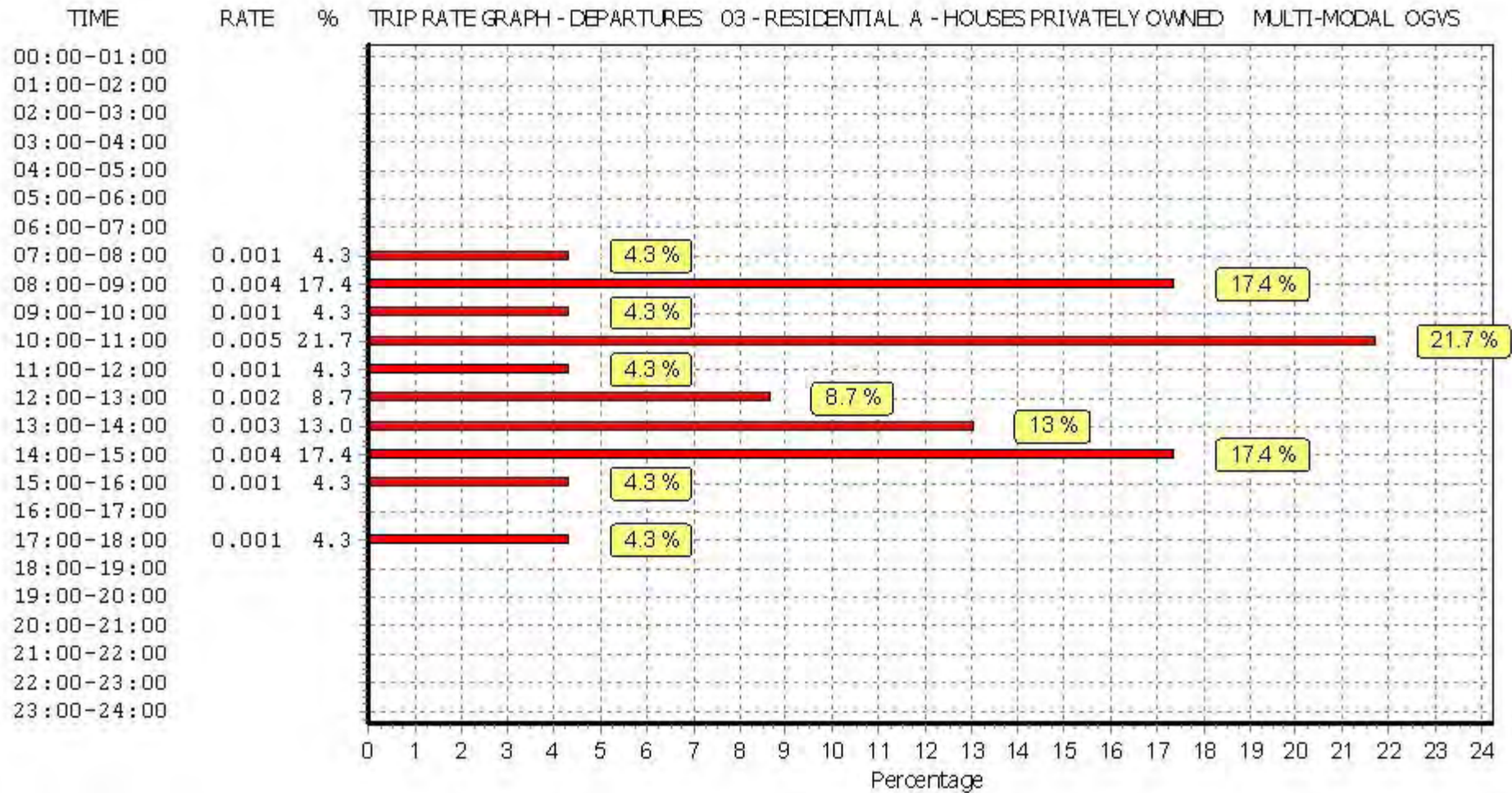

This graph is a visual representation of the trip rate calculation results screen. The same time periods and trip rates are displayed, but in addition there is an additional column showing the percentage of the total trip rate by individual time period, allowing peak periods to be easily identified through observation. Note that the type of count and the selected direction is shown at the top of the graph.

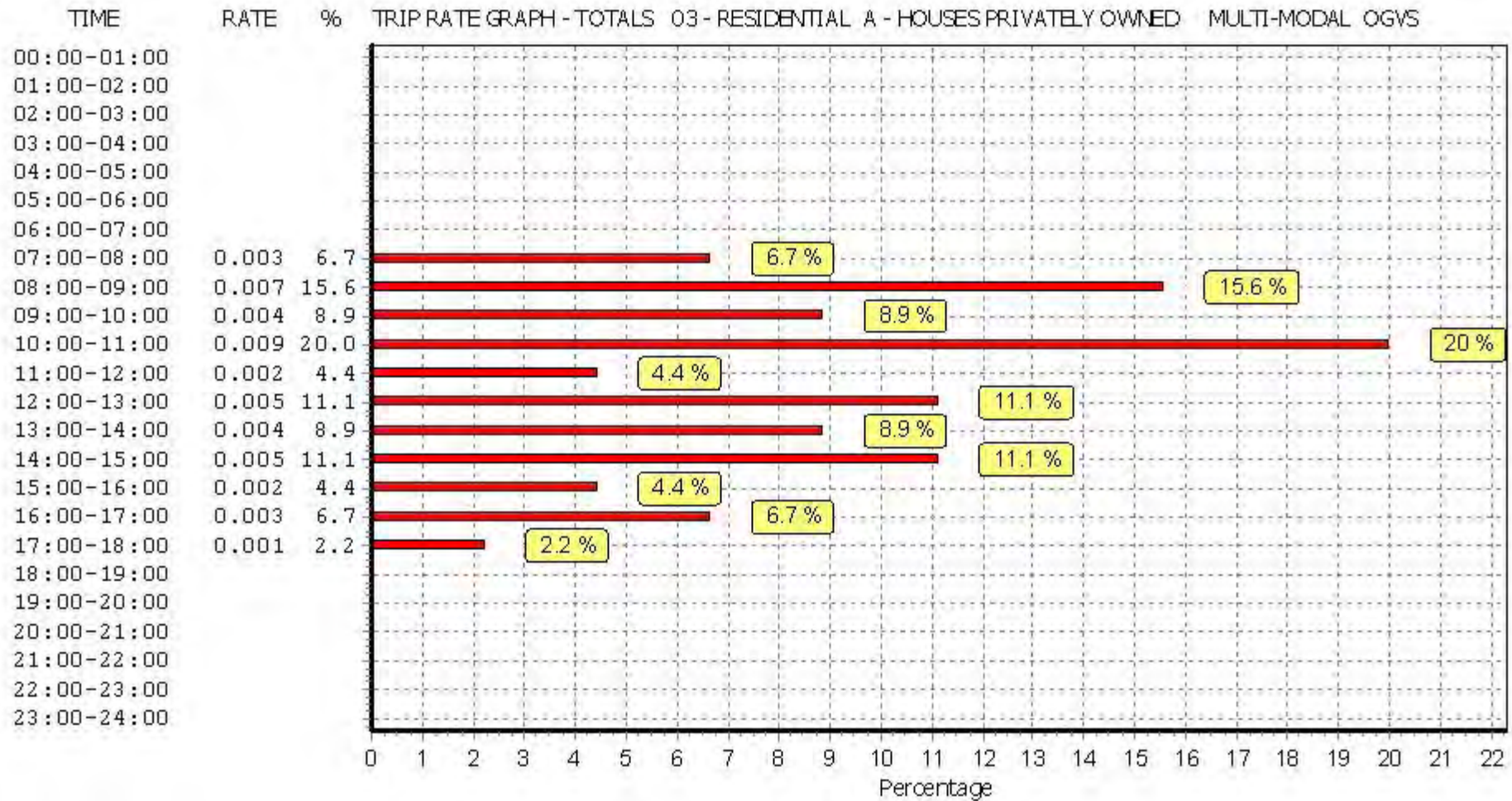

This graph is a visual representation of the trip rate calculation results screen. The same time periods and trip rates are displayed, but in addition there is an additional column showing the percentage of the total trip rate by individual time period, allowing peak periods to be easily identified through observation. Note that the type of count and the selected direction is shown at the top of the graph.

TRIP RATE for Land Use 03 - RESIDENTIAL/A - HOUSES PRIVATELY OWNED

MULTI-MODAL PSVS

Calculation factor: 1 DWELLS

BOLD print indicates peak (busiest) period

Time Range	ARRIVALS			DEPARTURES			TOTALS		
	No. Days	Ave. DWELLS	Trip Rate	No. Days	Ave. DWELLS	Trip Rate	No. Days	Ave. DWELLS	Trip Rate
00:00 - 01:00									
01:00 - 02:00									
02:00 - 03:00									
03:00 - 04:00									
04:00 - 05:00									
05:00 - 06:00									
06:00 - 07:00									
07:00 - 08:00	8	173	0.000	8	173	0.000	8	173	0.000
08:00 - 09:00	8	173	0.002	8	173	0.002	8	173	0.004
09:00 - 10:00	8	173	0.000	8	173	0.000	8	173	0.000
10:00 - 11:00	8	173	0.000	8	173	0.000	8	173	0.000
11:00 - 12:00	8	173	0.001	8	173	0.001	8	173	0.002
12:00 - 13:00	8	173	0.000	8	173	0.000	8	173	0.000
13:00 - 14:00	8	173	0.000	8	173	0.000	8	173	0.000
14:00 - 15:00	8	173	0.001	8	173	0.000	8	173	0.001
15:00 - 16:00	8	173	0.000	8	173	0.001	8	173	0.001
16:00 - 17:00	8	173	0.000	8	173	0.000	8	173	0.000
17:00 - 18:00	8	173	0.000	8	173	0.000	8	173	0.000
18:00 - 19:00	8	173	0.001	8	173	0.001	8	173	0.002
19:00 - 20:00									
20:00 - 21:00									
21:00 - 22:00									
22:00 - 23:00									
23:00 - 24:00									
<b>Total Rates:</b>			0.005			0.005			0.010

This section displays the trip rate results based on the selected set of surveys and the selected count type (shown just above the table). It is split by three main columns, representing arrivals trips, departures trips, and total trips (arrivals plus departures). Within each of these main columns are three sub-columns. These display the number of survey days where count data is included (per time period), the average value of the selected trip rate calculation parameter (per time period), and the trip rate result (per time period). Total trip rates (the sum of the column) are also displayed at the foot of the table.

To obtain a trip rate, the average (mean) trip rate parameter value (TRP) is first calculated for all selected survey days that have count data available for the stated time period. The average (mean) number of arrivals, departures or totals (whichever applies) is also calculated (COUNT) for all selected survey days that have count data available for the stated time period. Then, the average count is divided by the average trip rate parameter value, and multiplied by the stated calculation factor (shown just above the table and abbreviated here as FACT). So, the method is: COUNT/TRP\*FACT. Trip rates are then rounded to 3 decimal places.

Parameter summary

Trip rate parameter range selected: 101 - 432 (units: )  
 Survey date date range: 01/01/06 - 20/05/15  
 Number of weekdays (Monday-Friday): 8  
 Number of Saturdays: 0  
 Number of Sundays: 0  
 Surveys automatically removed from selection: 0  
 Surveys manually removed from selection: 1

This section displays a quick summary of some of the data filtering selections made by the TRICS® user. The trip rate calculation parameter range of all selected surveys is displayed first, followed by the range of minimum and maximum survey dates selected by the user. Then, the total number of selected weekdays and weekend days in the selected set of surveys are shown. Finally, the number of survey days that have been manually removed from the selected set outside of the standard filtering procedure are displayed.



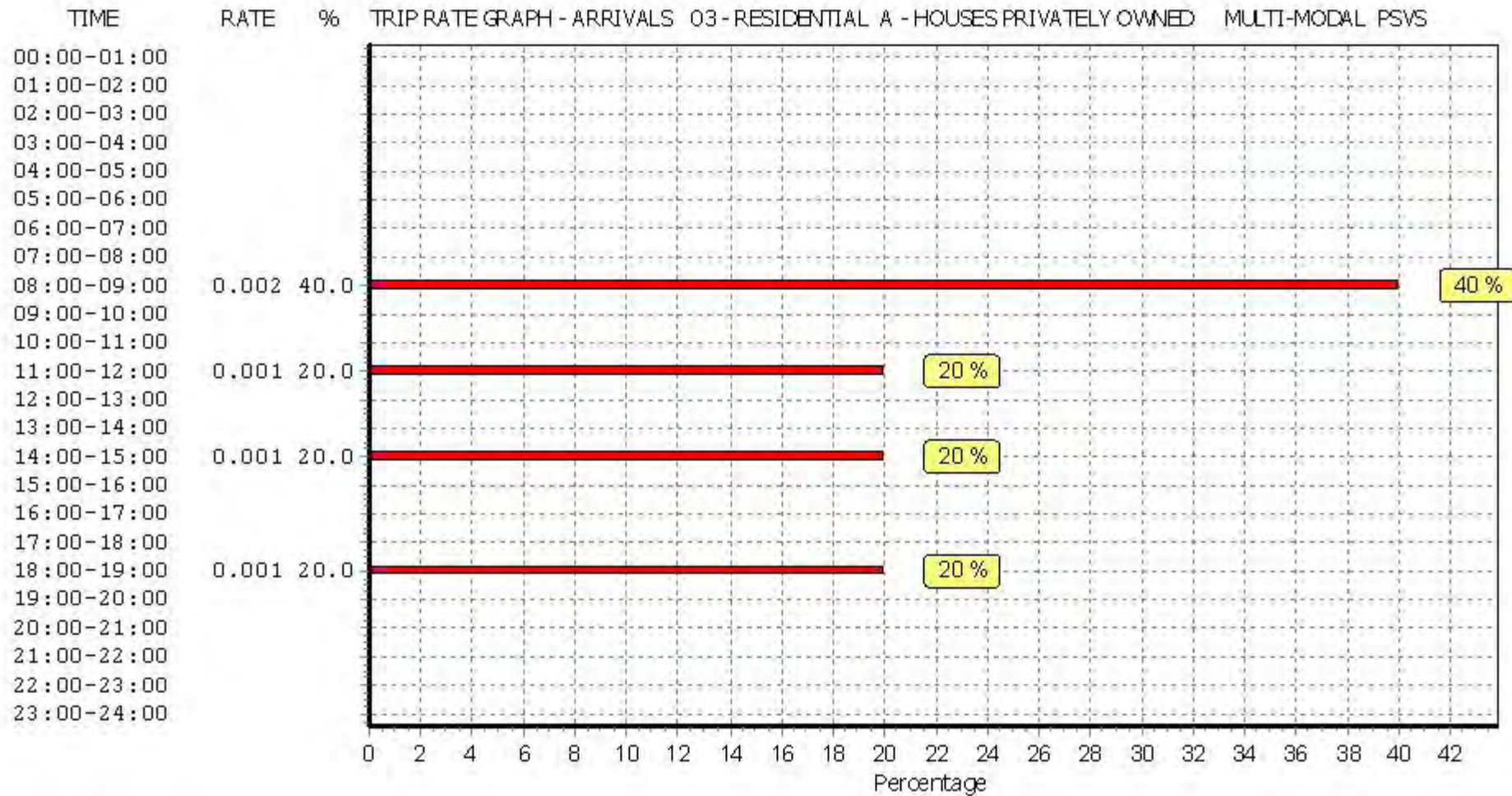

This graph is a visual representation of the trip rate calculation results screen. The same time periods and trip rates are displayed, but in addition there is an additional column showing the percentage of the total trip rate by individual time period, allowing peak periods to be easily identified through observation. Note that the type of count and the selected direction is shown at the top of the graph.

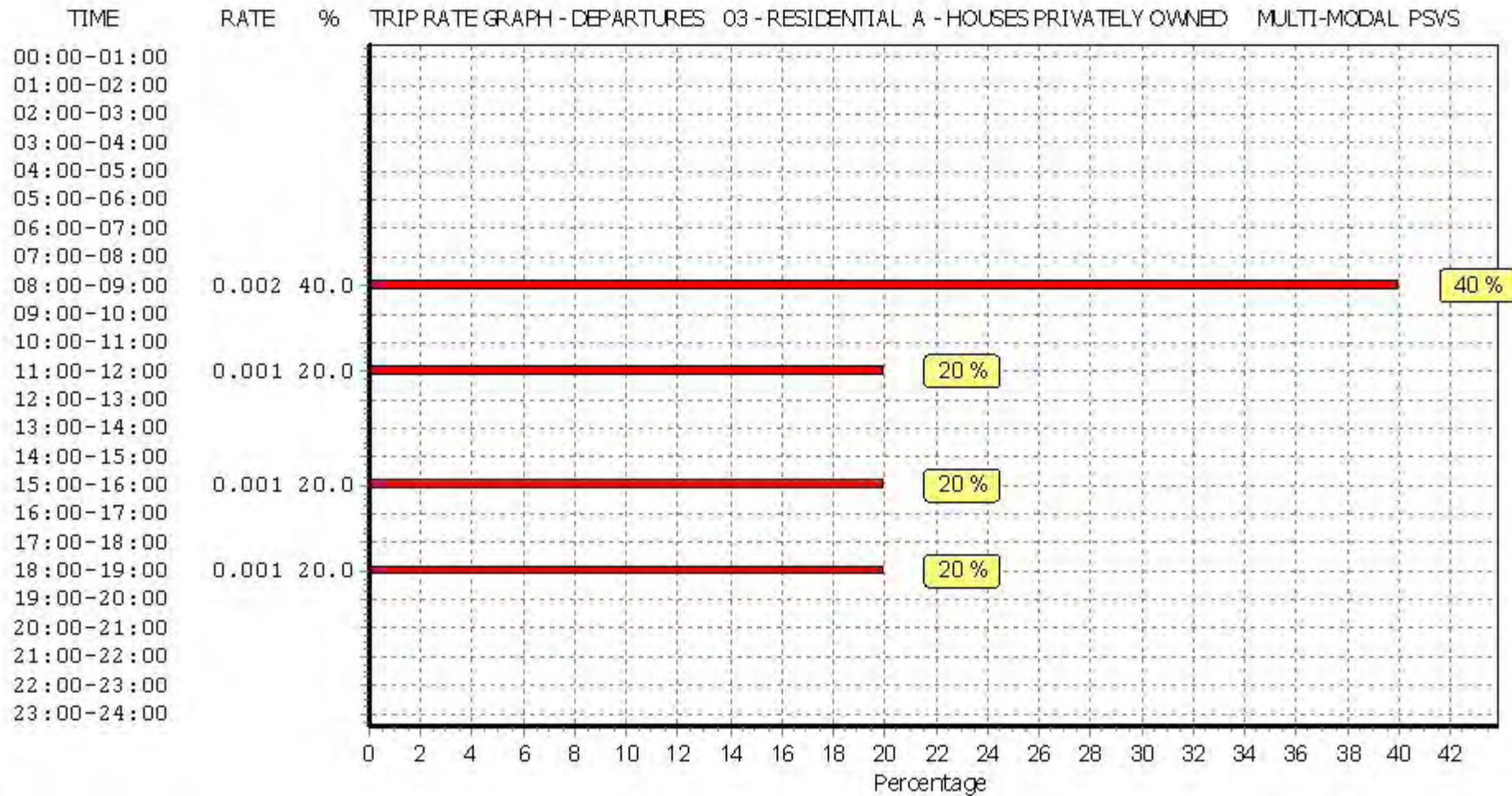

This graph is a visual representation of the trip rate calculation results screen. The same time periods and trip rates are displayed, but in addition there is an additional column showing the percentage of the total trip rate by individual time period, allowing peak periods to be easily identified through observation. Note that the type of count and the selected direction is shown at the top of the graph.



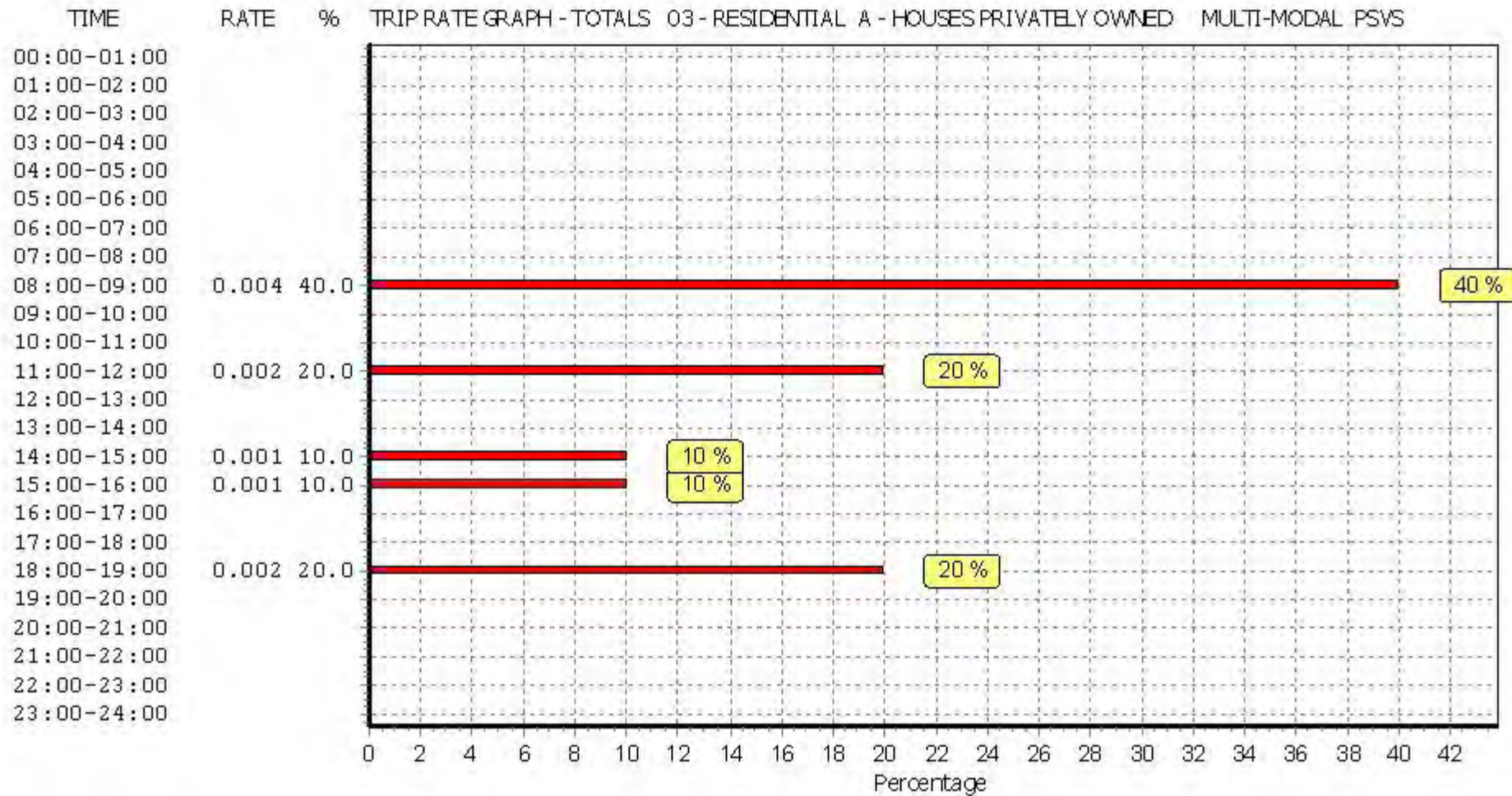

This graph is a visual representation of the trip rate calculation results screen. The same time periods and trip rates are displayed, but in addition there is an additional column showing the percentage of the total trip rate by individual time period, allowing peak periods to be easily identified through observation. Note that the type of count and the selected direction is shown at the top of the graph.

TRIP RATE for Land Use 03 - RESIDENTIAL/A - HOUSES PRIVATELY OWNED  
 MULTI-MODAL CYCLISTS  
 Calculation factor: 1 DWELLS  
 BOLD print indicates peak (busiest) period

Time Range	ARRIVALS			DEPARTURES			TOTALS		
	No. Days	Ave. DWELLS	Trip Rate	No. Days	Ave. DWELLS	Trip Rate	No. Days	Ave. DWELLS	Trip Rate
00:00 - 01:00									
01:00 - 02:00									
02:00 - 03:00									
03:00 - 04:00									
04:00 - 05:00									
05:00 - 06:00									
06:00 - 07:00									
07:00 - 08:00	8	173	0.006	8	173	0.009	8	173	0.015
08:00 - 09:00	8	173	0.006	8	173	0.022	8	173	0.028
09:00 - 10:00	8	173	0.005	8	173	0.005	8	173	0.010
10:00 - 11:00	8	173	0.001	8	173	0.007	8	173	0.008
11:00 - 12:00	8	173	0.004	8	173	0.000	8	173	0.004
12:00 - 13:00	8	173	0.003	8	173	0.006	8	173	0.009
13:00 - 14:00	8	173	0.005	8	173	0.004	8	173	0.009
14:00 - 15:00	8	173	0.004	8	173	0.003	8	173	0.007
15:00 - 16:00	8	173	0.014	8	173	0.004	8	173	0.018
16:00 - 17:00	8	173	0.012	8	173	0.004	8	173	0.016
17:00 - 18:00	8	173	0.007	8	173	0.011	8	173	0.018
18:00 - 19:00	8	173	0.007	8	173	0.001	8	173	0.008
19:00 - 20:00									
20:00 - 21:00									
21:00 - 22:00									
22:00 - 23:00									
23:00 - 24:00									
<b>Total Rates:</b>			<b>0.074</b>			<b>0.076</b>			<b>0.150</b>

This section displays the trip rate results based on the selected set of surveys and the selected count type (shown just above the table). It is split by three main columns, representing arrivals trips, departures trips, and total trips (arrivals plus departures). Within each of these main columns are three sub-columns. These display the number of survey days where count data is included (per time period), the average value of the selected trip rate calculation parameter (per time period), and the trip rate result (per time period). Total trip rates (the sum of the column) are also displayed at the foot of the table.

To obtain a trip rate, the average (mean) trip rate parameter value (TRP) is first calculated for all selected survey days that have count data available for the stated time period. The average (mean) number of arrivals, departures or totals (whichever applies) is also calculated (COUNT) for all selected survey days that have count data available for the stated time period. Then, the average count is divided by the average trip rate parameter value, and multiplied by the stated calculation factor (shown just above the table and abbreviated here as FACT). So, the method is: COUNT/TRP\*FACT. Trip rates are then rounded to 3 decimal places.

Parameter summary

Trip rate parameter range selected: 101 - 432 (units: )  
 Survey date date range: 01/01/06 - 20/05/15  
 Number of weekdays (Monday-Friday): 8  
 Number of Saturdays: 0  
 Number of Sundays: 0  
 Surveys automatically removed from selection: 0  
 Surveys manually removed from selection: 1

This section displays a quick summary of some of the data filtering selections made by the TRICS® user. The trip rate calculation parameter range of all selected surveys is displayed first, followed by the range of minimum and maximum survey dates selected by the user. Then, the total number of selected weekdays and weekend days in the selected set of surveys are show. Finally, the number of survey days that have been manually removed from the selected set outside of the standard filtering procedure are displayed.

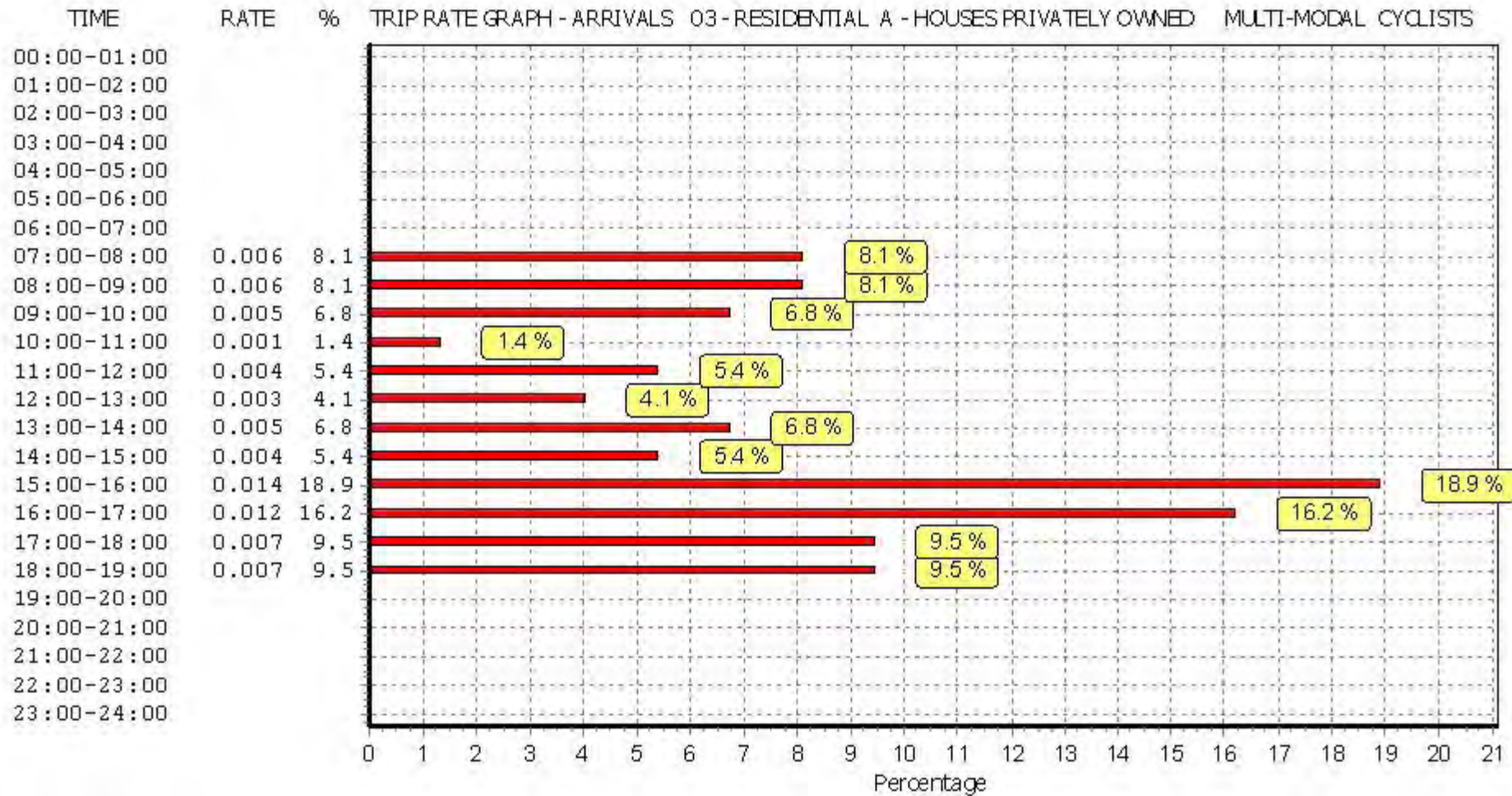

This graph is a visual representation of the trip rate calculation results screen. The same time periods and trip rates are displayed, but in addition there is an additional column showing the percentage of the total trip rate by individual time period, allowing peak periods to be easily identified through observation. Note that the type of count and the selected direction is shown at the top of the graph.



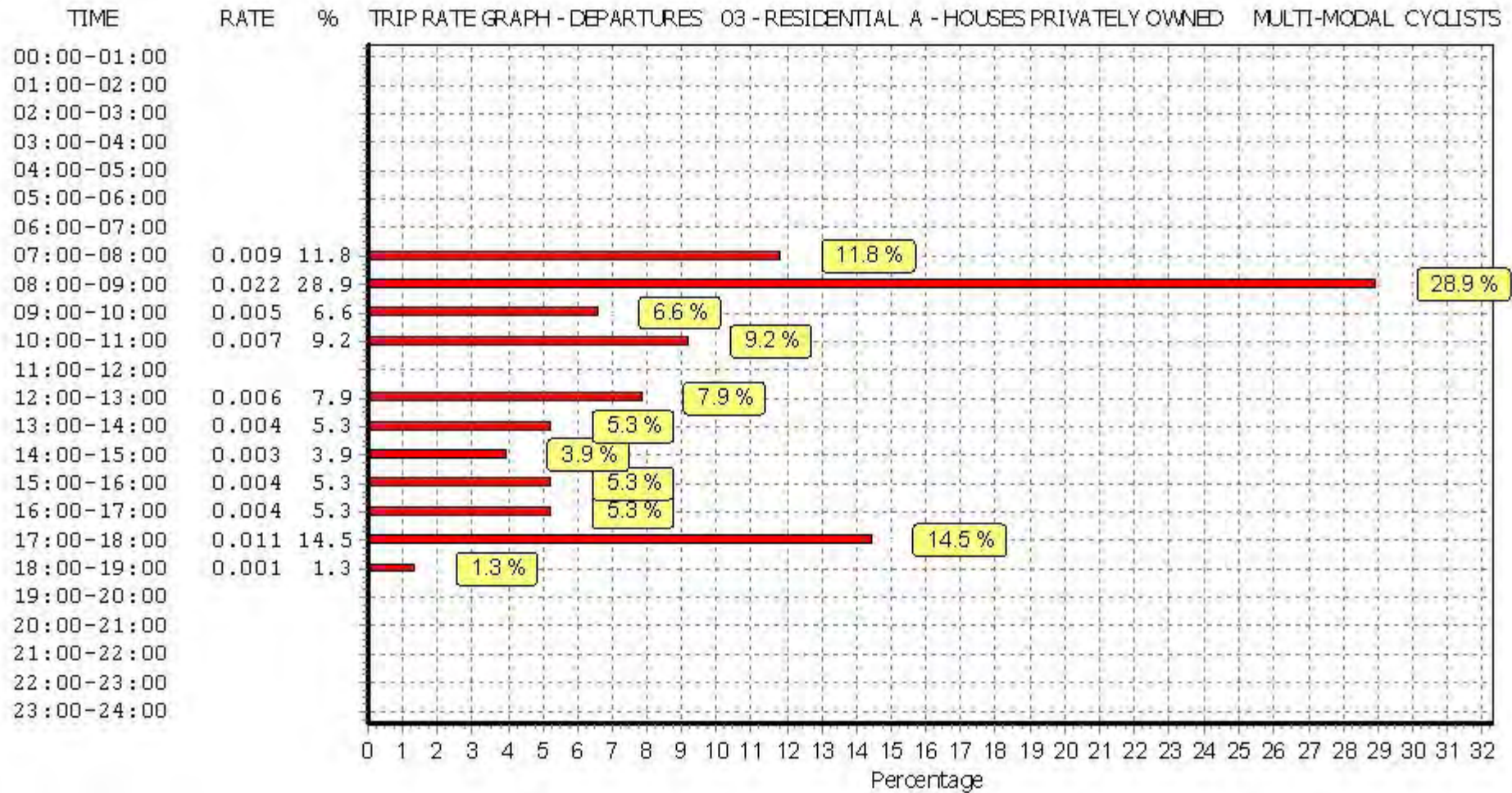

This graph is a visual representation of the trip rate calculation results screen. The same time periods and trip rates are displayed, but in addition there is an additional column showing the percentage of the total trip rate by individual time period, allowing peak periods to be easily identified through observation. Note that the type of count and the selected direction is shown at the top of the graph.



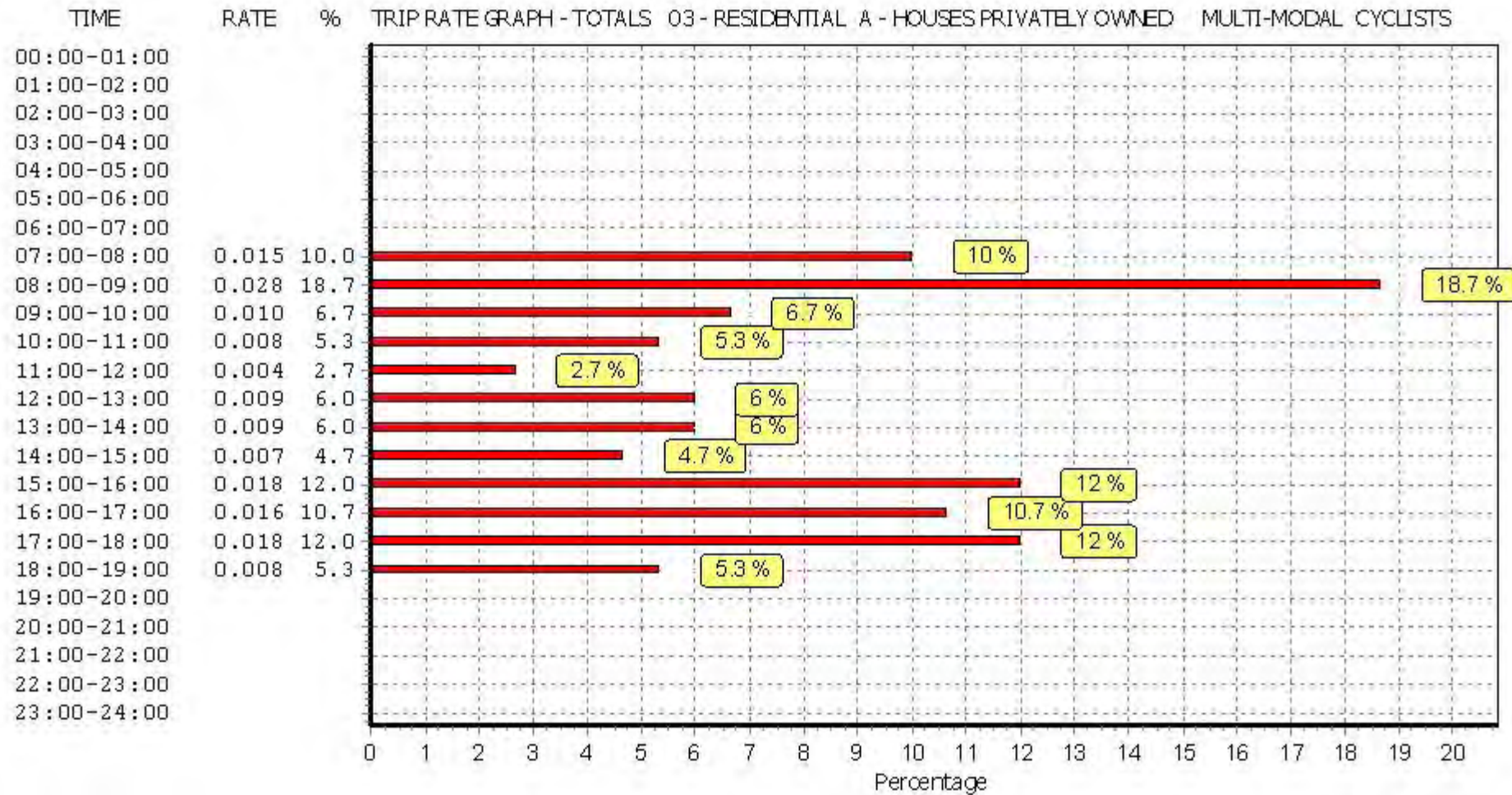

This graph is a visual representation of the trip rate calculation results screen. The same time periods and trip rates are displayed, but in addition there is an additional column showing the percentage of the total trip rate by individual time period, allowing peak periods to be easily identified through observation. Note that the type of count and the selected direction is shown at the top of the graph.

TRIP RATE for Land Use 03 - RESIDENTIAL/A - HOUSES PRIVATELY OWNED  
 MULTI-MODAL VEHICLE OCCUPANTS  
 Calculation factor: 1 DWELLS  
 BOLD print indicates peak (busiest) period

Time Range	ARRIVALS			DEPARTURES			TOTALS		
	No. Days	Ave. DWELLS	Trip Rate	No. Days	Ave. DWELLS	Trip Rate	No. Days	Ave. DWELLS	Trip Rate
00:00 - 01:00									
01:00 - 02:00									
02:00 - 03:00									
03:00 - 04:00									
04:00 - 05:00									
05:00 - 06:00									
06:00 - 07:00									
07:00 - 08:00	8	173	0.084	8	173	0.307	8	173	0.391
08:00 - 09:00	8	173	0.156	8	173	0.620	8	173	0.776
09:00 - 10:00	8	173	0.191	8	173	0.264	8	173	0.455
10:00 - 11:00	8	173	0.179	8	173	0.228	8	173	0.407
11:00 - 12:00	8	173	0.189	8	173	0.179	8	173	0.368
12:00 - 13:00	8	173	0.240	8	173	0.231	8	173	0.471
13:00 - 14:00	8	173	0.211	8	173	0.218	8	173	0.429
14:00 - 15:00	8	173	0.228	8	173	0.262	8	173	0.490
15:00 - 16:00	8	173	0.437	8	173	0.270	8	173	0.707
16:00 - 17:00	8	173	0.492	8	173	0.265	8	173	0.757
17:00 - 18:00	8	173	0.473	8	173	0.296	8	173	0.769
18:00 - 19:00	8	173	0.328	8	173	0.311	8	173	0.639
19:00 - 20:00									
20:00 - 21:00									
21:00 - 22:00									
22:00 - 23:00									
23:00 - 24:00									
<b>Total Rates:</b>			3.208			3.451			6.659

This section displays the trip rate results based on the selected set of surveys and the selected count type (shown just above the table). It is split by three main columns, representing arrivals trips, departures trips, and total trips (arrivals plus departures). Within each of these main columns are three sub-columns. These display the number of survey days where count data is included (per time period), the average value of the selected trip rate calculation parameter (per time period), and the trip rate result (per time period). Total trip rates (the sum of the column) are also displayed at the foot of the table.

To obtain a trip rate, the average (mean) trip rate parameter value (TRP) is first calculated for all selected survey days that have count data available for the stated time period. The average (mean) number of arrivals, departures or totals (whichever applies) is also calculated (COUNT) for all selected survey days that have count data available for the stated time period. Then, the average count is divided by the average trip rate parameter value, and multiplied by the stated calculation factor (shown just above the table and abbreviated here as FACT). So, the method is: COUNT/TRP\*FACT. Trip rates are then rounded to 3 decimal places.

Parameter summary

Trip rate parameter range selected: 101 - 432 (units: )  
 Survey date date range: 01/01/06 - 20/05/15  
 Number of weekdays (Monday-Friday): 8  
 Number of Saturdays: 0  
 Number of Sundays: 0  
 Surveys automatically removed from selection: 0  
 Surveys manually removed from selection: 1

This section displays a quick summary of some of the data filtering selections made by the TRICS® user. The trip rate calculation parameter range of all selected surveys is displayed first, followed by the range of minimum and maximum survey dates selected by the user. Then, the total number of selected weekdays and weekend days in the selected set of surveys are show. Finally, the number of survey days that have been manually removed from the selected set outside of the standard filtering procedure are displayed.

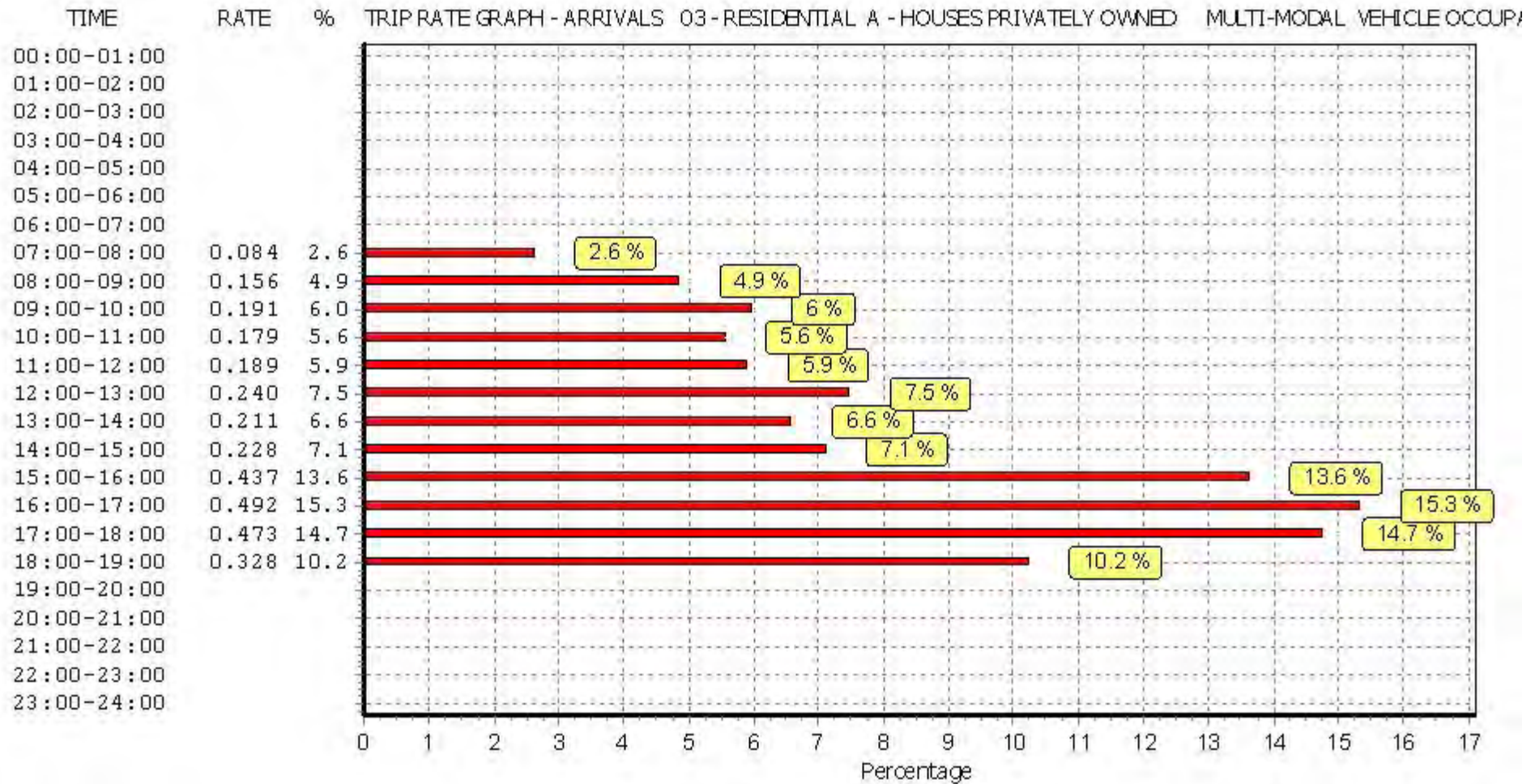

This graph is a visual representation of the trip rate calculation results screen. The same time periods and trip rates are displayed, but in addition there is an additional column showing the percentage of the total trip rate by individual time period, allowing peak periods to be easily identified through observation. Note that the type of count and the selected direction is shown at the top of the graph.



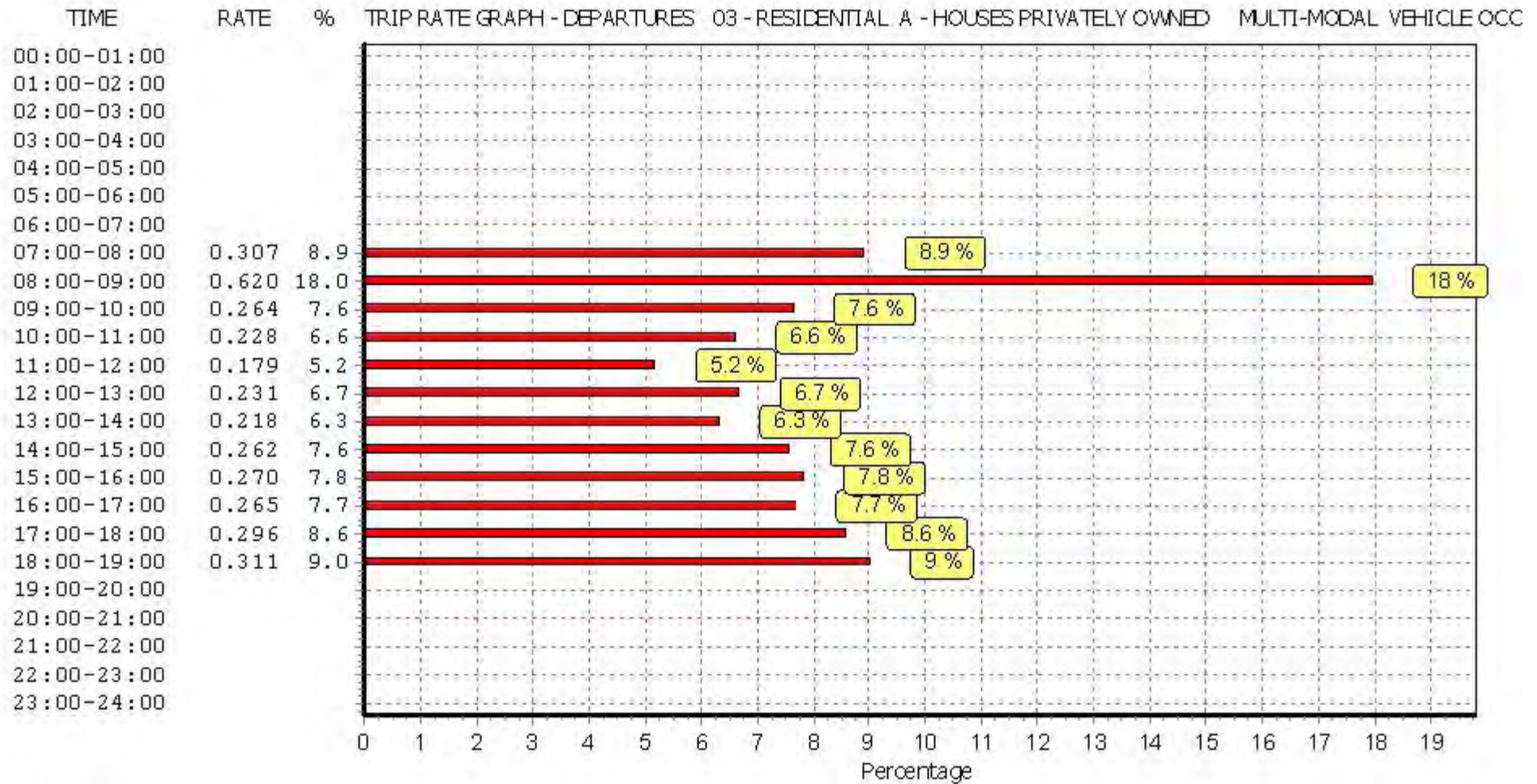

This graph is a visual representation of the trip rate calculation results screen. The same time periods and trip rates are displayed, but in addition there is an additional column showing the percentage of the total trip rate by individual time period, allowing peak periods to be easily identified through observation. Note that the type of count and the selected direction is shown at the top of the graph.

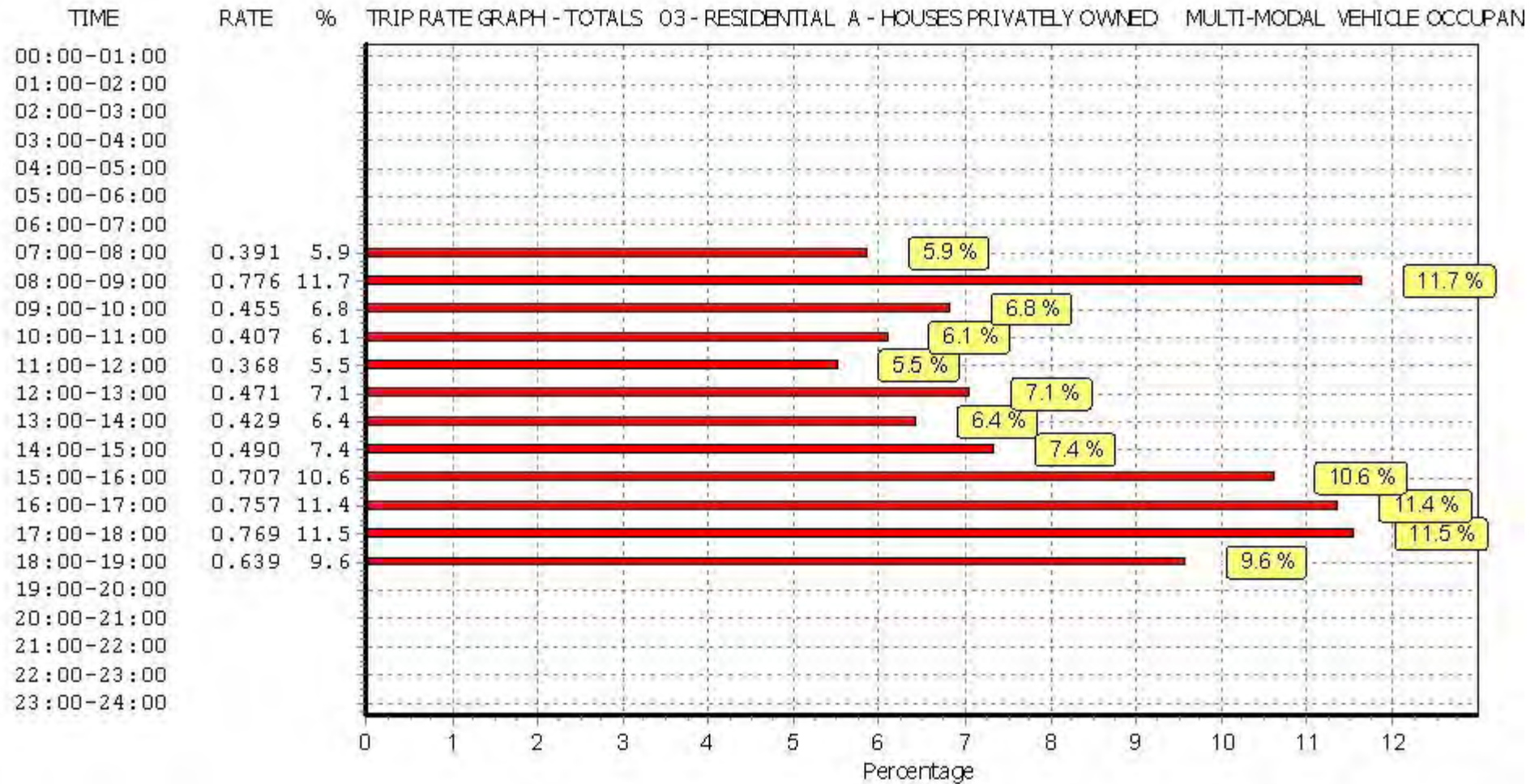

This graph is a visual representation of the trip rate calculation results screen. The same time periods and trip rates are displayed, but in addition there is an additional column showing the percentage of the total trip rate by individual time period, allowing peak periods to be easily identified through observation. Note that the type of count and the selected direction is shown at the top of the graph.

TRIP RATE for Land Use 03 - RESIDENTIAL/A - HOUSES PRIVATELY OWNED  
 MULTI-MODAL PEDESTRIANS  
 Calculation factor: 1 DWELLS  
 BOLD print indicates peak (busiest) period

Time Range	ARRIVALS			DEPARTURES			TOTALS		
	No. Days	Ave. DWELLS	Trip Rate	No. Days	Ave. DWELLS	Trip Rate	No. Days	Ave. DWELLS	Trip Rate
00:00 - 01:00									
01:00 - 02:00									
02:00 - 03:00									
03:00 - 04:00									
04:00 - 05:00									
05:00 - 06:00									
06:00 - 07:00									
07:00 - 08:00	8	173	0.025	8	173	0.039	8	173	0.064
08:00 - 09:00	8	173	0.022	8	173	0.101	8	173	0.123
09:00 - 10:00	8	173	0.036	8	173	0.041	8	173	0.077
10:00 - 11:00	8	173	0.036	8	173	0.040	8	173	0.076
11:00 - 12:00	8	173	0.027	8	173	0.026	8	173	0.053
12:00 - 13:00	8	173	0.024	8	173	0.025	8	173	0.049
13:00 - 14:00	8	173	0.020	8	173	0.034	8	173	0.054
14:00 - 15:00	8	173	0.043	8	173	0.039	8	173	0.082
15:00 - 16:00	8	173	0.082	8	173	0.045	8	173	0.127
16:00 - 17:00	8	173	0.061	8	173	0.035	8	173	0.096
17:00 - 18:00	8	173	0.035	8	173	0.030	8	173	0.065
18:00 - 19:00	8	173	0.043	8	173	0.041	8	173	0.084
19:00 - 20:00									
20:00 - 21:00									
21:00 - 22:00									
22:00 - 23:00									
23:00 - 24:00									
<b>Total Rates:</b>			0.454			0.496			0.950

This section displays the trip rate results based on the selected set of surveys and the selected count type (shown just above the table). It is split by three main columns, representing arrivals trips, departures trips, and total trips (arrivals plus departures). Within each of these main columns are three sub-columns. These display the number of survey days where count data is included (per time period), the average value of the selected trip rate calculation parameter (per time period), and the trip rate result (per time period). Total trip rates (the sum of the column) are also displayed at the foot of the table.

To obtain a trip rate, the average (mean) trip rate parameter value (TRP) is first calculated for all selected survey days that have count data available for the stated time period. The average (mean) number of arrivals, departures or totals (whichever applies) is also calculated (COUNT) for all selected survey days that have count data available for the stated time period. Then, the average count is divided by the average trip rate parameter value, and multiplied by the stated calculation factor (shown just above the table and abbreviated here as FACT). So, the method is: COUNT/TRP\*FACT. Trip rates are then rounded to 3 decimal places.

Parameter summary

Trip rate parameter range selected: 101 - 432 (units: )  
 Survey date date range: 01/01/06 - 20/05/15  
 Number of weekdays (Monday-Friday): 8  
 Number of Saturdays: 0  
 Number of Sundays: 0  
 Surveys automatically removed from selection: 0  
 Surveys manually removed from selection: 1

This section displays a quick summary of some of the data filtering selections made by the TRICS® user. The trip rate calculation parameter range of all selected surveys is displayed first, followed by the range of minimum and maximum survey dates selected by the user. Then, the total number of selected weekdays and weekend days in the selected set of surveys are show. Finally, the number of survey days that have been manually removed from the selected set outside of the standard filtering procedure are displayed.



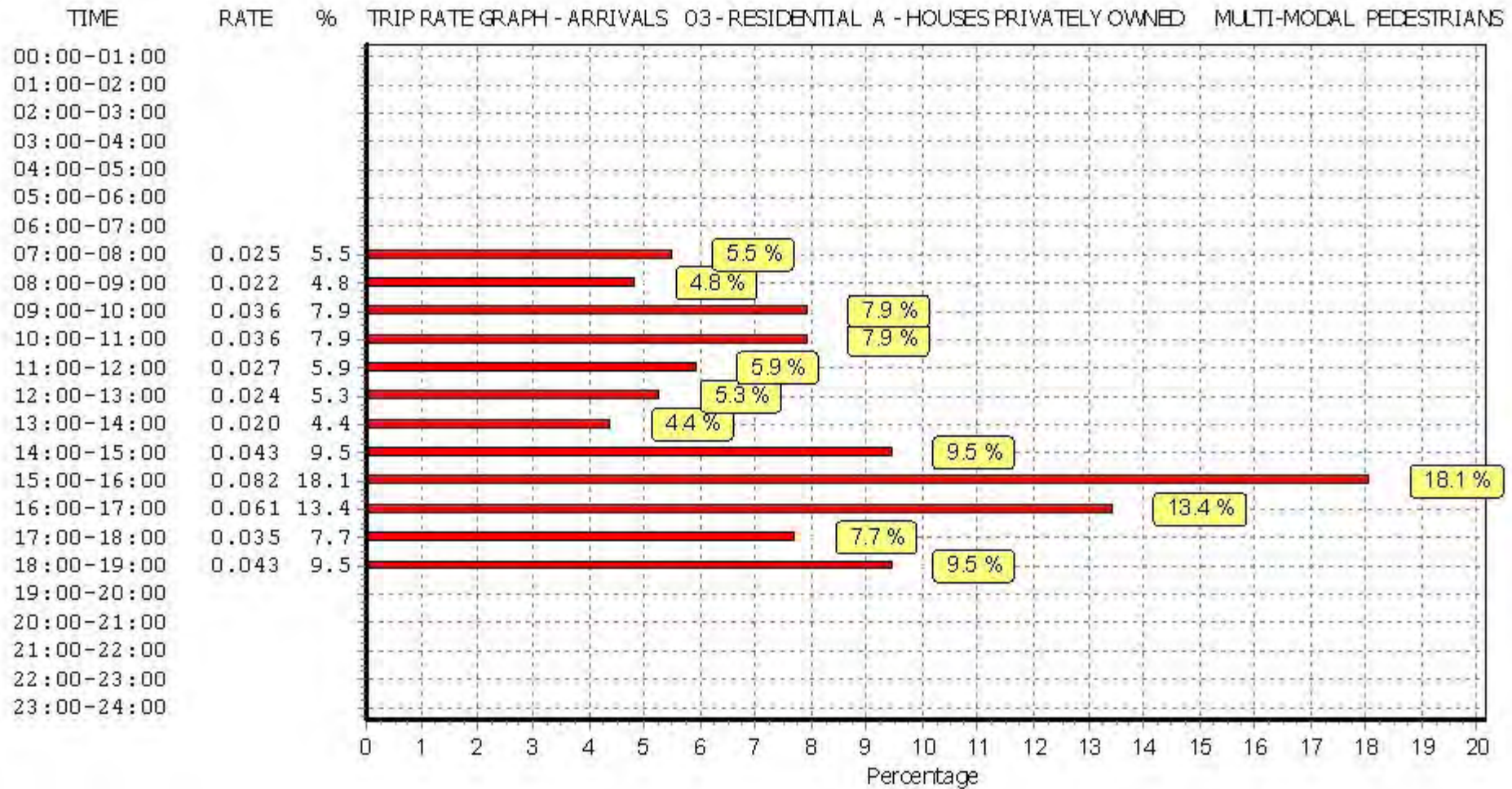

This graph is a visual representation of the trip rate calculation results screen. The same time periods and trip rates are displayed, but in addition there is an additional column showing the percentage of the total trip rate by individual time period, allowing peak periods to be easily identified through observation. Note that the type of count and the selected direction is shown at the top of the graph.

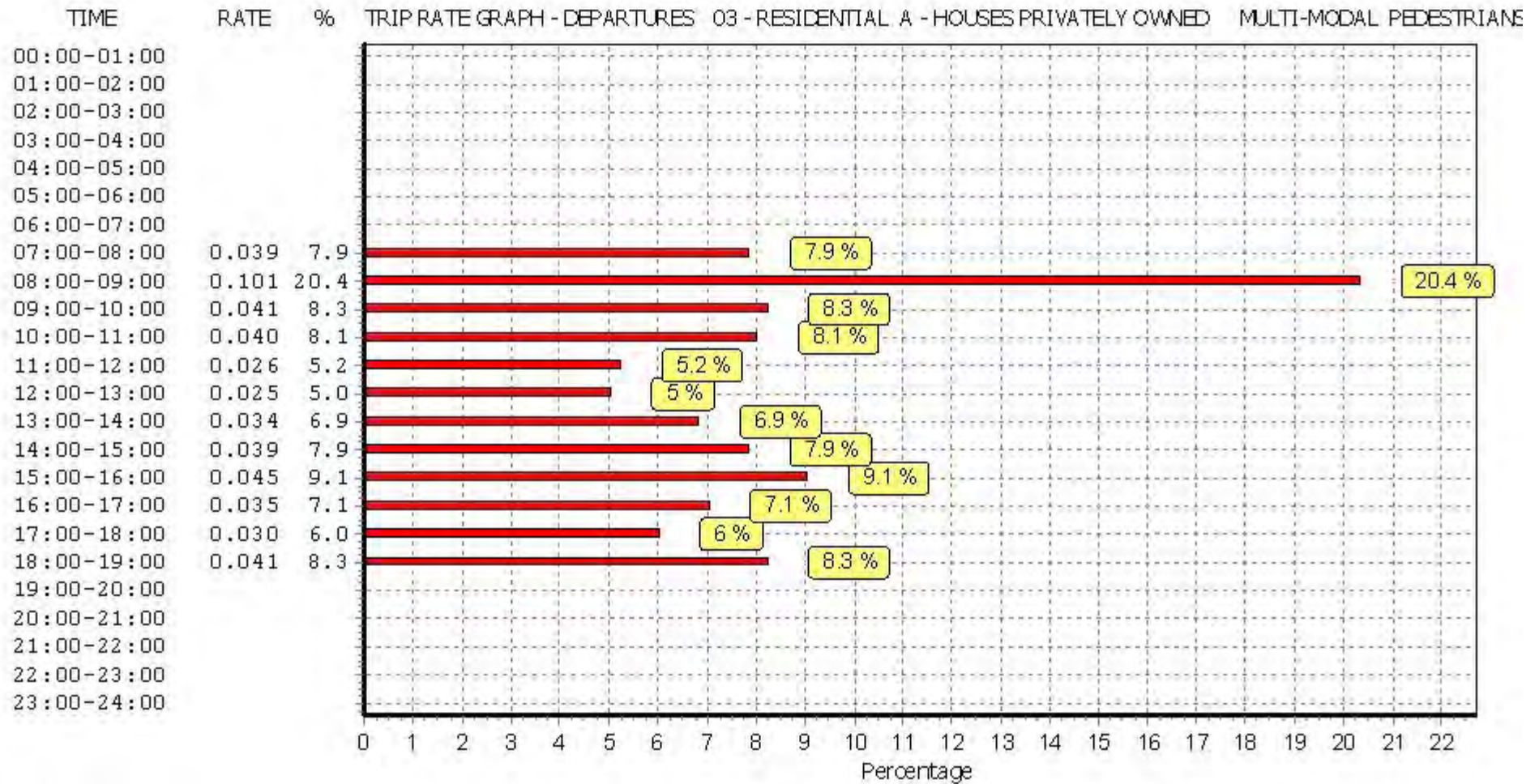

This graph is a visual representation of the trip rate calculation results screen. The same time periods and trip rates are displayed, but in addition there is an additional column showing the percentage of the total trip rate by individual time period, allowing peak periods to be easily identified through observation. Note that the type of count and the selected direction is shown at the top of the graph.



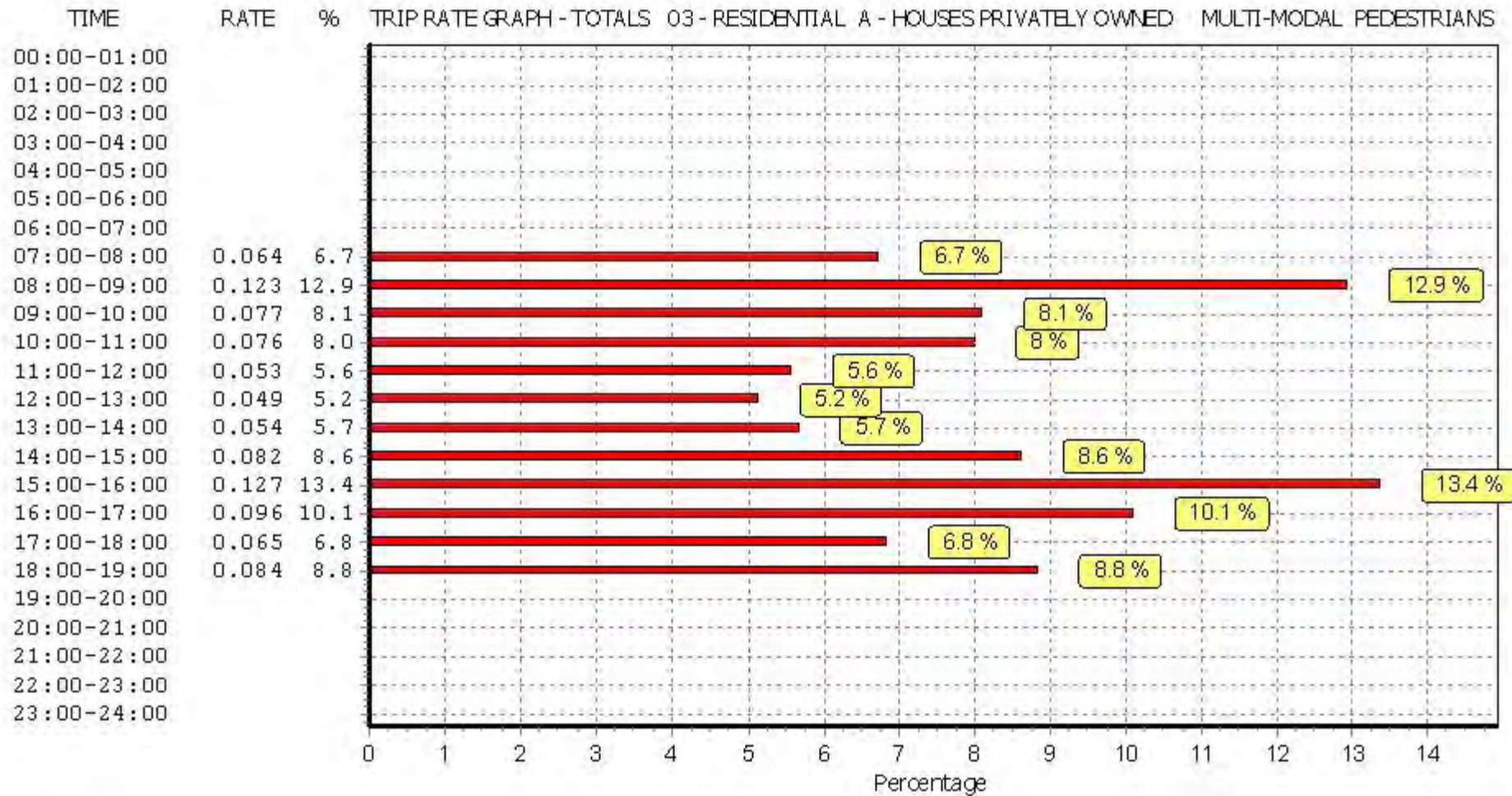

This graph is a visual representation of the trip rate calculation results screen. The same time periods and trip rates are displayed, but in addition there is an additional column showing the percentage of the total trip rate by individual time period, allowing peak periods to be easily identified through observation. Note that the type of count and the selected direction is shown at the top of the graph.

TRIP RATE for Land Use 03 - RESIDENTIAL/A - HOUSES PRIVATELY OWNED  
 MULTI-MODAL BUS/TRAM PASSENGERS  
 Calculation factor: 1 DWELLS  
 BOLD print indicates peak (busiest) period

Time Range	ARRIVALS			DEPARTURES			TOTALS		
	No. Days	Ave. DWELLS	Trip Rate	No. Days	Ave. DWELLS	Trip Rate	No. Days	Ave. DWELLS	Trip Rate
00:00 - 01:00									
01:00 - 02:00									
02:00 - 03:00									
03:00 - 04:00									
04:00 - 05:00									
05:00 - 06:00									
06:00 - 07:00									
07:00 - 08:00	8	173	0.000	8	173	0.004	8	173	0.004
08:00 - 09:00	8	173	0.000	8	173	0.005	8	173	0.005
09:00 - 10:00	8	173	0.001	8	173	0.007	8	173	0.008
10:00 - 11:00	8	173	0.003	8	173	0.002	8	173	0.005
11:00 - 12:00	8	173	0.004	8	173	0.004	8	173	0.008
12:00 - 13:00	8	173	0.004	8	173	0.004	8	173	0.008
13:00 - 14:00	8	173	0.007	8	173	0.003	8	173	0.010
14:00 - 15:00	8	173	0.002	8	173	0.003	8	173	0.005
15:00 - 16:00	8	173	0.006	8	173	0.001	8	173	0.007
16:00 - 17:00	8	173	0.004	8	173	0.001	8	173	0.005
17:00 - 18:00	8	173	0.004	8	173	0.001	8	173	0.005
18:00 - 19:00	8	173	0.004	8	173	0.000	8	173	0.004
19:00 - 20:00									
20:00 - 21:00									
21:00 - 22:00									
22:00 - 23:00									
23:00 - 24:00									
<b>Total Rates:</b>			<b>0.039</b>			<b>0.035</b>			<b>0.074</b>

This section displays the trip rate results based on the selected set of surveys and the selected count type (shown just above the table). It is split by three main columns, representing arrivals trips, departures trips, and total trips (arrivals plus departures). Within each of these main columns are three sub-columns. These display the number of survey days where count data is included (per time period), the average value of the selected trip rate calculation parameter (per time period), and the trip rate result (per time period). Total trip rates (the sum of the column) are also displayed at the foot of the table.

To obtain a trip rate, the average (mean) trip rate parameter value (TRP) is first calculated for all selected survey days that have count data available for the stated time period. The average (mean) number of arrivals, departures or totals (whichever applies) is also calculated (COUNT) for all selected survey days that have count data available for the stated time period. Then, the average count is divided by the average trip rate parameter value, and multiplied by the stated calculation factor (shown just above the table and abbreviated here as FACT). So, the method is: COUNT/TRP\*FACT. Trip rates are then rounded to 3 decimal places.

Parameter summary

Trip rate parameter range selected: 101 - 432 (units: )  
 Survey date date range: 01/01/06 - 20/05/15  
 Number of weekdays (Monday-Friday): 8  
 Number of Saturdays: 0  
 Number of Sundays: 0  
 Surveys automatically removed from selection: 0  
 Surveys manually removed from selection: 1

This section displays a quick summary of some of the data filtering selections made by the TRICS® user. The trip rate calculation parameter range of all selected surveys is displayed first, followed by the range of minimum and maximum survey dates selected by the user. Then, the total number of selected weekdays and weekend days in the selected set of surveys are show. Finally, the number of survey days that have been manually removed from the selected set outside of the standard filtering procedure are displayed.

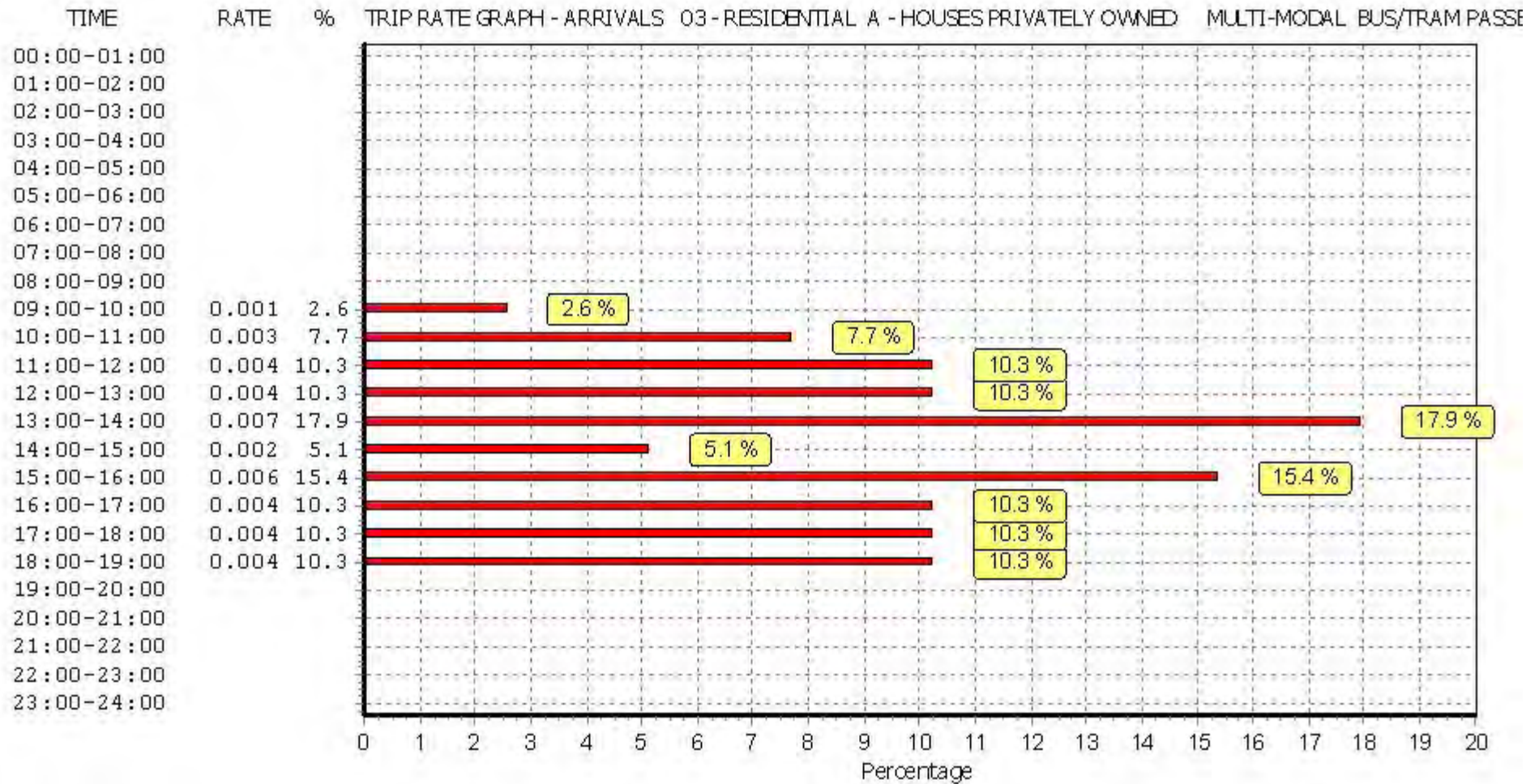

This graph is a visual representation of the trip rate calculation results screen. The same time periods and trip rates are displayed, but in addition there is an additional column showing the percentage of the total trip rate by individual time period, allowing peak periods to be easily identified through observation. Note that the type of count and the selected direction is shown at the top of the graph.



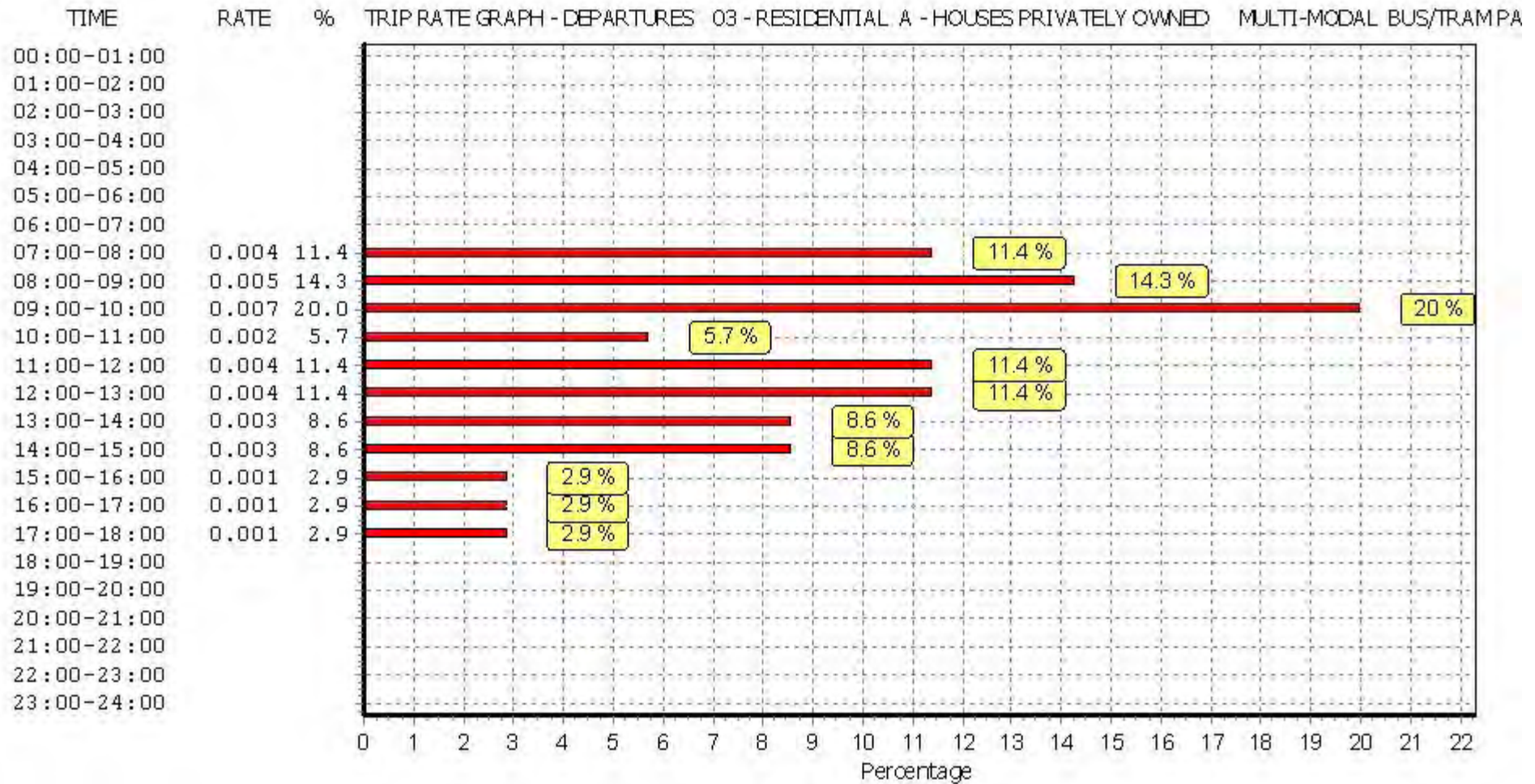

This graph is a visual representation of the trip rate calculation results screen. The same time periods and trip rates are displayed, but in addition there is an additional column showing the percentage of the total trip rate by individual time period, allowing peak periods to be easily identified through observation. Note that the type of count and the selected direction is shown at the top of the graph.

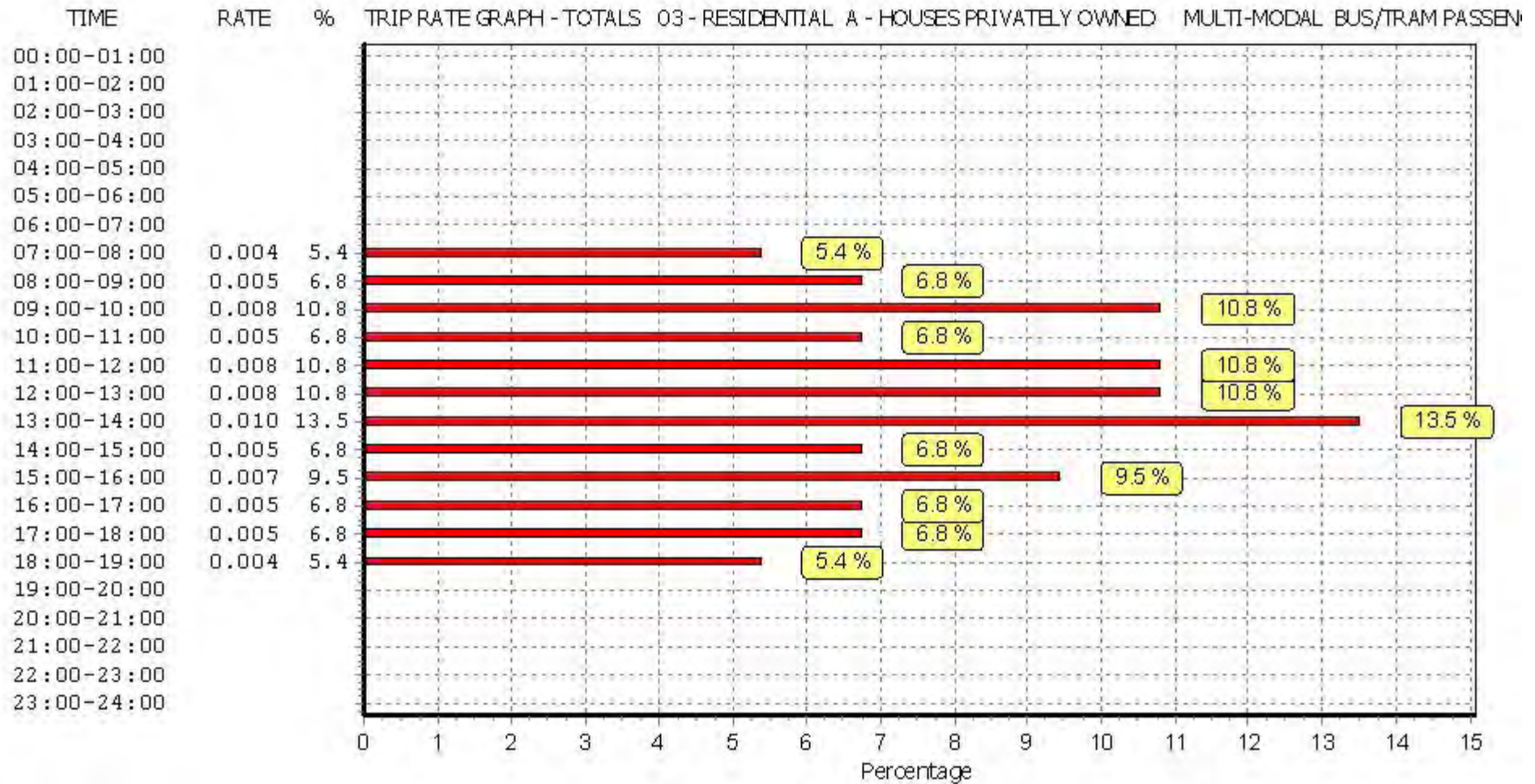

This graph is a visual representation of the trip rate calculation results screen. The same time periods and trip rates are displayed, but in addition there is an additional column showing the percentage of the total trip rate by individual time period, allowing peak periods to be easily identified through observation. Note that the type of count and the selected direction is shown at the top of the graph.

TRIP RATE for Land Use 03 - RESIDENTIAL/A - HOUSES PRIVATELY OWNED  
 MULTI-MODAL TOTAL RAIL PASSENGERS  
 Calculation factor: 1 DWELLS  
 BOLD print indicates peak (busiest) period

Time Range	ARRIVALS			DEPARTURES			TOTALS		
	No. Days	Ave. DWELLS	Trip Rate	No. Days	Ave. DWELLS	Trip Rate	No. Days	Ave. DWELLS	Trip Rate
00:00 - 01:00									
01:00 - 02:00									
02:00 - 03:00									
03:00 - 04:00									
04:00 - 05:00									
05:00 - 06:00									
06:00 - 07:00									
07:00 - 08:00	8	173	0.000	8	173	0.000	8	173	0.000
08:00 - 09:00	8	173	0.000	8	173	0.001	8	173	0.001
09:00 - 10:00	8	173	0.000	8	173	0.001	8	173	0.001
10:00 - 11:00	8	173	0.000	8	173	0.000	8	173	0.000
11:00 - 12:00	8	173	0.000	8	173	0.000	8	173	0.000
12:00 - 13:00	8	173	0.000	8	173	0.000	8	173	0.000
13:00 - 14:00	8	173	0.000	8	173	0.000	8	173	0.000
14:00 - 15:00	8	173	0.000	8	173	0.000	8	173	0.000
15:00 - 16:00	8	173	0.001	8	173	0.000	8	173	0.001
16:00 - 17:00	8	173	0.000	8	173	0.000	8	173	0.000
17:00 - 18:00	8	173	0.000	8	173	0.000	8	173	0.000
18:00 - 19:00	8	173	0.000	8	173	0.000	8	173	0.000
19:00 - 20:00									
20:00 - 21:00									
21:00 - 22:00									
22:00 - 23:00									
23:00 - 24:00									
<b>Total Rates:</b>			0.001			0.002			0.003

This section displays the trip rate results based on the selected set of surveys and the selected count type (shown just above the table). It is split by three main columns, representing arrivals trips, departures trips, and total trips (arrivals plus departures). Within each of these main columns are three sub-columns. These display the number of survey days where count data is included (per time period), the average value of the selected trip rate calculation parameter (per time period), and the trip rate result (per time period). Total trip rates (the sum of the column) are also displayed at the foot of the table.

To obtain a trip rate, the average (mean) trip rate parameter value (TRP) is first calculated for all selected survey days that have count data available for the stated time period. The average (mean) number of arrivals, departures or totals (whichever applies) is also calculated (COUNT) for all selected survey days that have count data available for the stated time period. Then, the average count is divided by the average trip rate parameter value, and multiplied by the stated calculation factor (shown just above the table and abbreviated here as FACT). So, the method is: COUNT/TRP\*FACT. Trip rates are then rounded to 3 decimal places.

Parameter summary

Trip rate parameter range selected: 101 - 432 (units: )  
 Survey date date range: 01/01/06 - 20/05/15  
 Number of weekdays (Monday-Friday): 8  
 Number of Saturdays: 0  
 Number of Sundays: 0  
 Surveys automatically removed from selection: 0  
 Surveys manually removed from selection: 1

This section displays a quick summary of some of the data filtering selections made by the TRICS® user. The trip rate calculation parameter range of all selected surveys is displayed first, followed by the range of minimum and maximum survey dates selected by the user. Then, the total number of selected weekdays and weekend days in the selected set of surveys are show. Finally, the number of survey days that have been manually removed from the selected set outside of the standard filtering procedure are displayed.



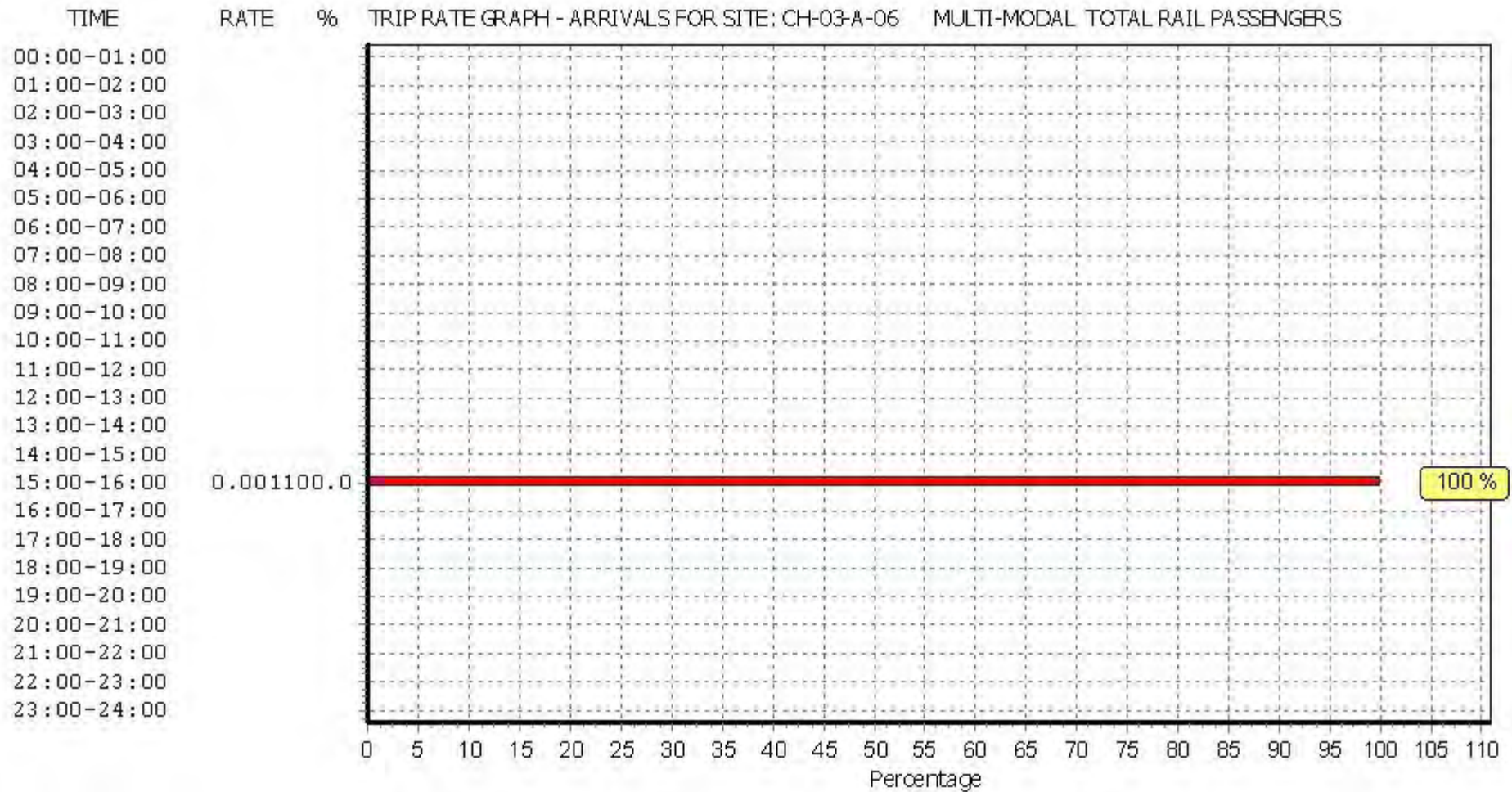

This graph is a visual representation of the trip rate calculation results screen. The same time periods and trip rates are displayed, but in addition there is an additional column showing the percentage of the total trip rate by individual time period, allowing peak periods to be easily identified through observation. Note that the type of count and the selected direction is shown at the top of the graph.

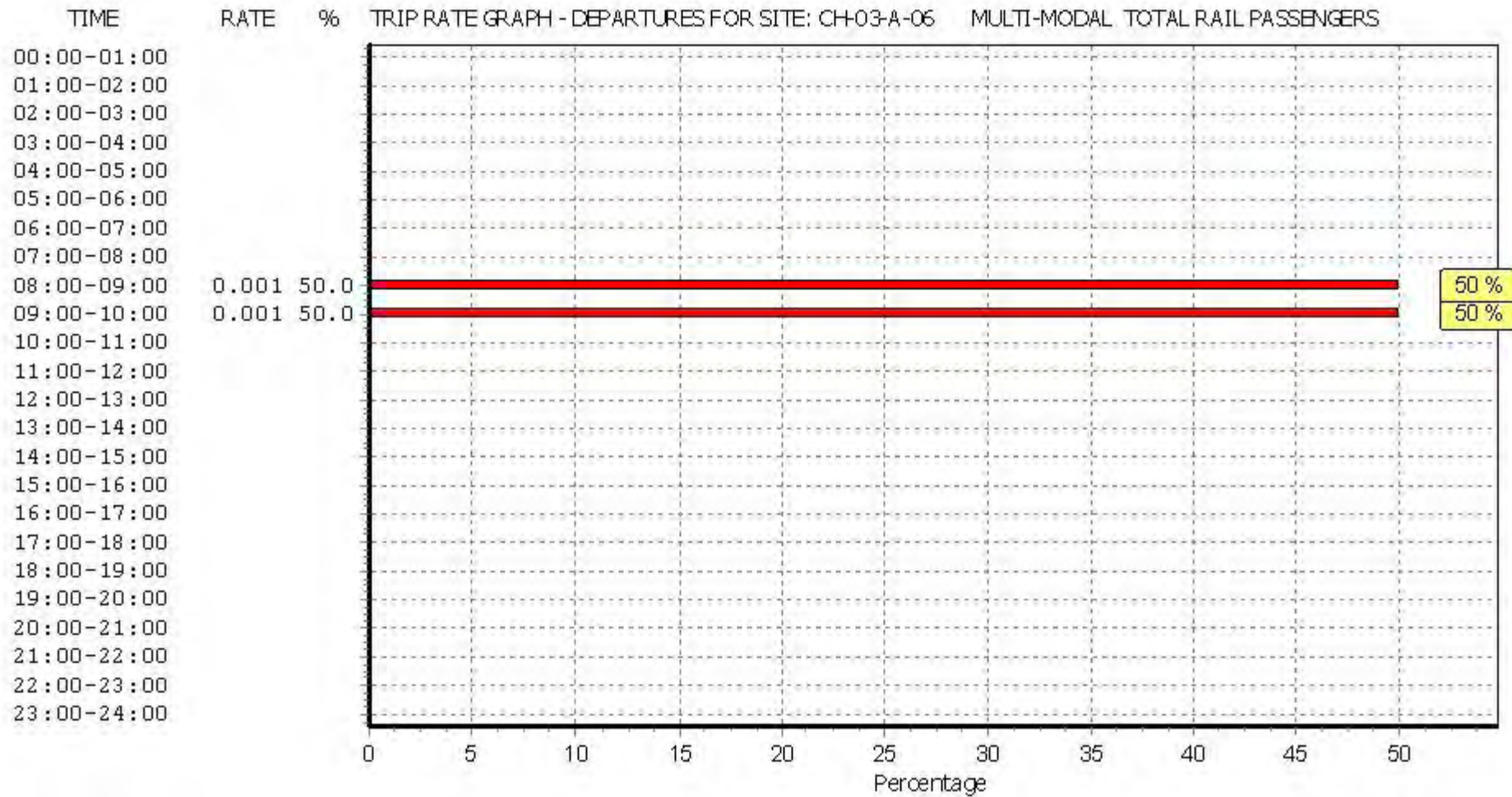

This graph is a visual representation of the trip rate calculation results screen. The same time periods and trip rates are displayed, but in addition there is an additional column showing the percentage of the total trip rate by individual time period, allowing peak periods to be easily identified through observation. Note that the type of count and the selected direction is shown at the top of the graph.



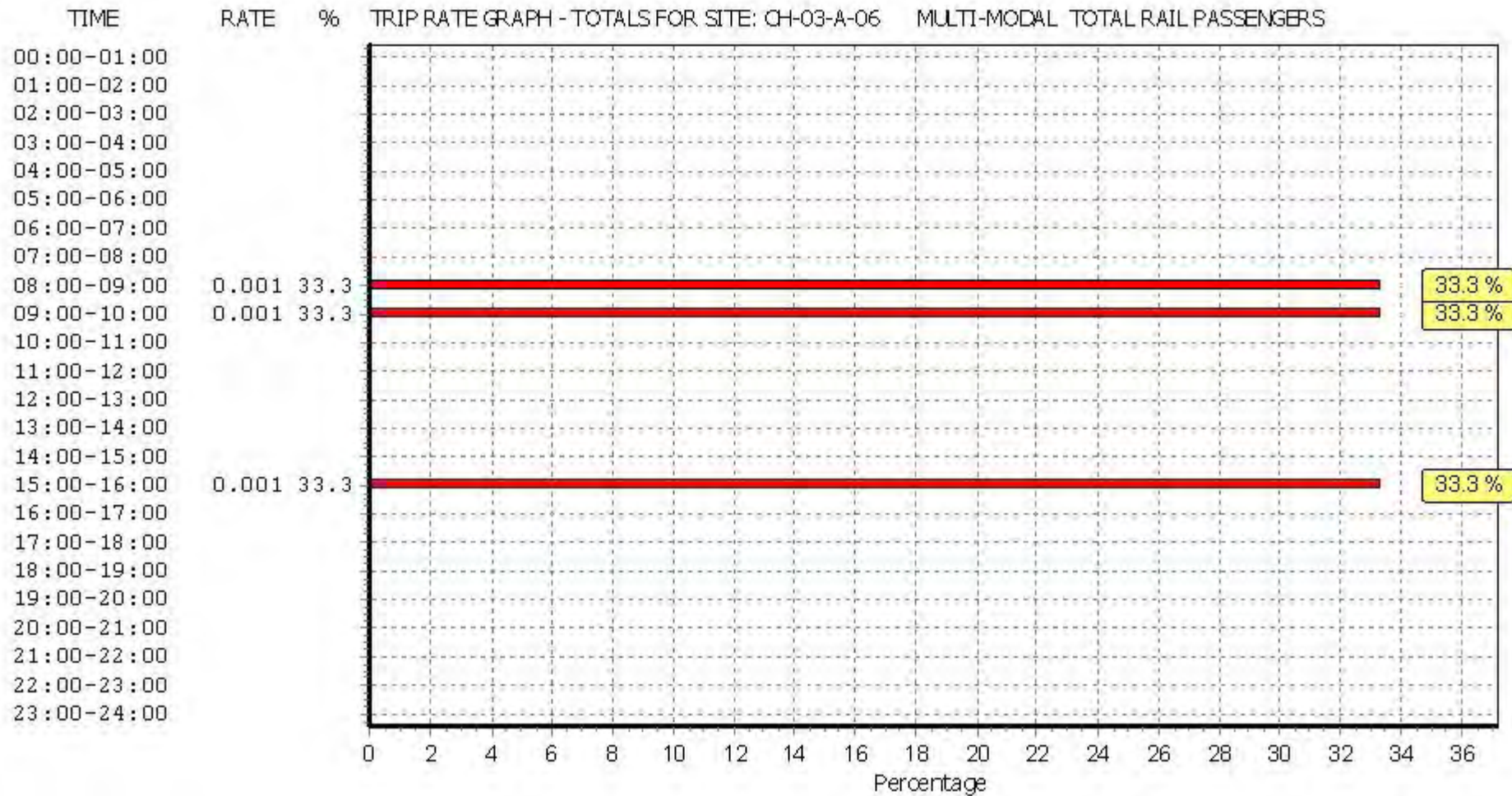

This graph is a visual representation of the trip rate calculation results screen. The same time periods and trip rates are displayed, but in addition there is an additional column showing the percentage of the total trip rate by individual time period, allowing peak periods to be easily identified through observation. Note that the type of count and the selected direction is shown at the top of the graph.

TRIP RATE for Land Use 03 - RESIDENTIAL/A - HOUSES PRIVATELY OWNED  
 MULTI-MODAL COACH PASSENGERS  
 Calculation factor: 1 DWELLS  
 BOLD print indicates peak (busiest) period

Time Range	ARRIVALS			DEPARTURES			TOTALS		
	No. Days	Ave. DWELLS	Trip Rate	No. Days	Ave. DWELLS	Trip Rate	No. Days	Ave. DWELLS	Trip Rate
00:00 - 01:00									
01:00 - 02:00									
02:00 - 03:00									
03:00 - 04:00									
04:00 - 05:00									
05:00 - 06:00									
06:00 - 07:00									
07:00 - 08:00	8	173	0.000	8	173	0.000	8	173	0.000
08:00 - 09:00	8	173	0.001	8	173	0.006	8	173	0.007
09:00 - 10:00	8	173	0.000	8	173	0.000	8	173	0.000
10:00 - 11:00	8	173	0.000	8	173	0.000	8	173	0.000
11:00 - 12:00	8	173	0.003	8	173	0.001	8	173	0.004
12:00 - 13:00	8	173	0.000	8	173	0.000	8	173	0.000
13:00 - 14:00	8	173	0.000	8	173	0.000	8	173	0.000
14:00 - 15:00	8	173	0.001	8	173	0.000	8	173	0.001
15:00 - 16:00	8	173	0.000	8	173	0.000	8	173	0.000
16:00 - 17:00	8	173	0.000	8	173	0.000	8	173	0.000
17:00 - 18:00	8	173	0.000	8	173	0.000	8	173	0.000
18:00 - 19:00	8	173	0.001	8	173	0.000	8	173	0.001
19:00 - 20:00									
20:00 - 21:00									
21:00 - 22:00									
22:00 - 23:00									
23:00 - 24:00									
<b>Total Rates:</b>			0.006			0.007			0.013

This section displays the trip rate results based on the selected set of surveys and the selected count type (shown just above the table). It is split by three main columns, representing arrivals trips, departures trips, and total trips (arrivals plus departures). Within each of these main columns are three sub-columns. These display the number of survey days where count data is included (per time period), the average value of the selected trip rate calculation parameter (per time period), and the trip rate result (per time period). Total trip rates (the sum of the column) are also displayed at the foot of the table.

To obtain a trip rate, the average (mean) trip rate parameter value (TRP) is first calculated for all selected survey days that have count data available for the stated time period. The average (mean) number of arrivals, departures or totals (whichever applies) is also calculated (COUNT) for all selected survey days that have count data available for the stated time period. Then, the average count is divided by the average trip rate parameter value, and multiplied by the stated calculation factor (shown just above the table and abbreviated here as FACT). So, the method is: COUNT/TRP\*FACT. Trip rates are then rounded to 3 decimal places.

Parameter summary

Trip rate parameter range selected: 101 - 432 (units: )  
 Survey date date range: 01/01/06 - 20/05/15  
 Number of weekdays (Monday-Friday): 8  
 Number of Saturdays: 0  
 Number of Sundays: 0  
 Surveys automatically removed from selection: 0  
 Surveys manually removed from selection: 1

This section displays a quick summary of some of the data filtering selections made by the TRICS® user. The trip rate calculation parameter range of all selected surveys is displayed first, followed by the range of minimum and maximum survey dates selected by the user. Then, the total number of selected weekdays and weekend days in the selected set of surveys are show. Finally, the number of survey days that have been manually removed from the selected set outside of the standard filtering procedure are displayed.

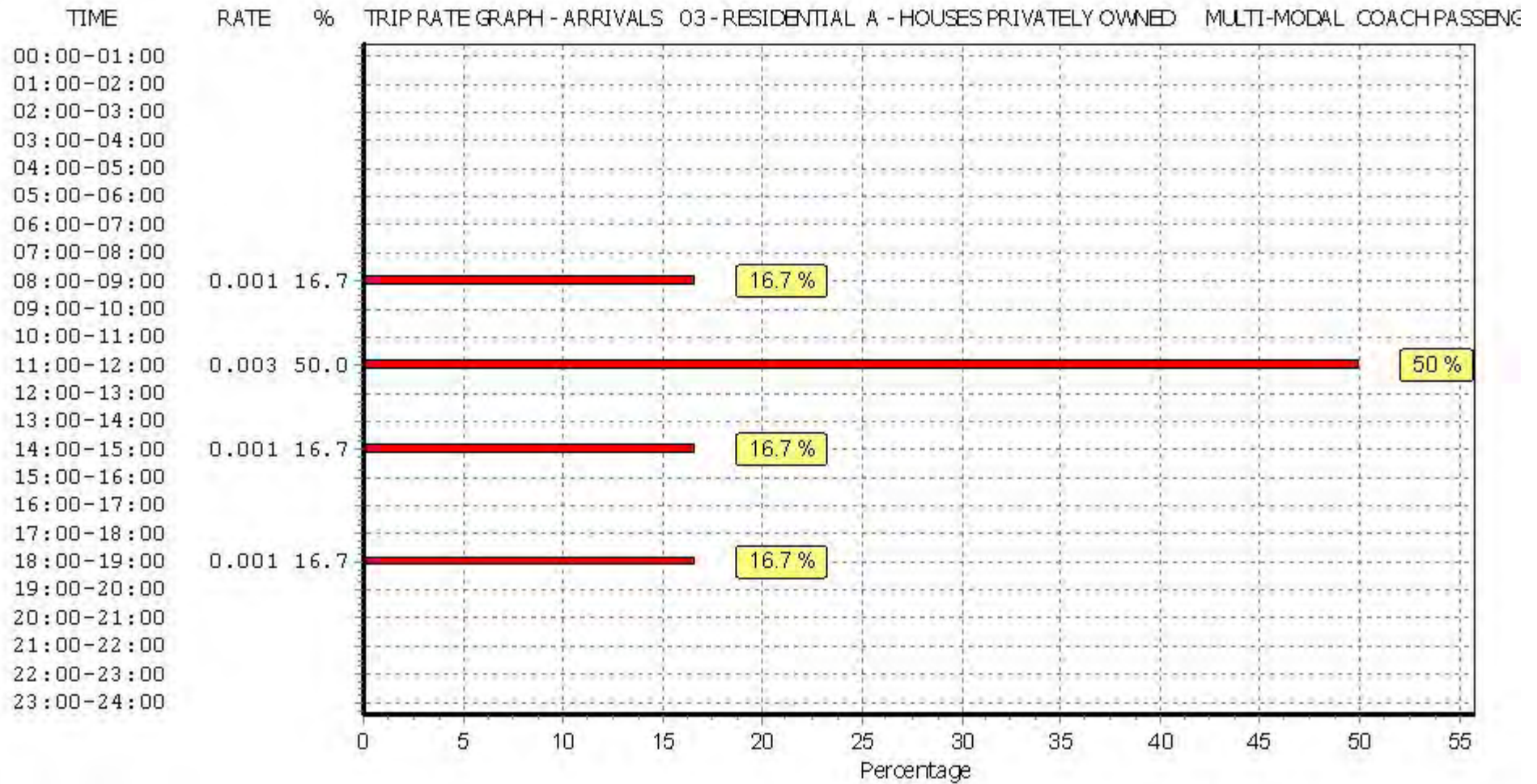

This graph is a visual representation of the trip rate calculation results screen. The same time periods and trip rates are displayed, but in addition there is an additional column showing the percentage of the total trip rate by individual time period, allowing peak periods to be easily identified through observation. Note that the type of count and the selected direction is shown at the top of the graph.



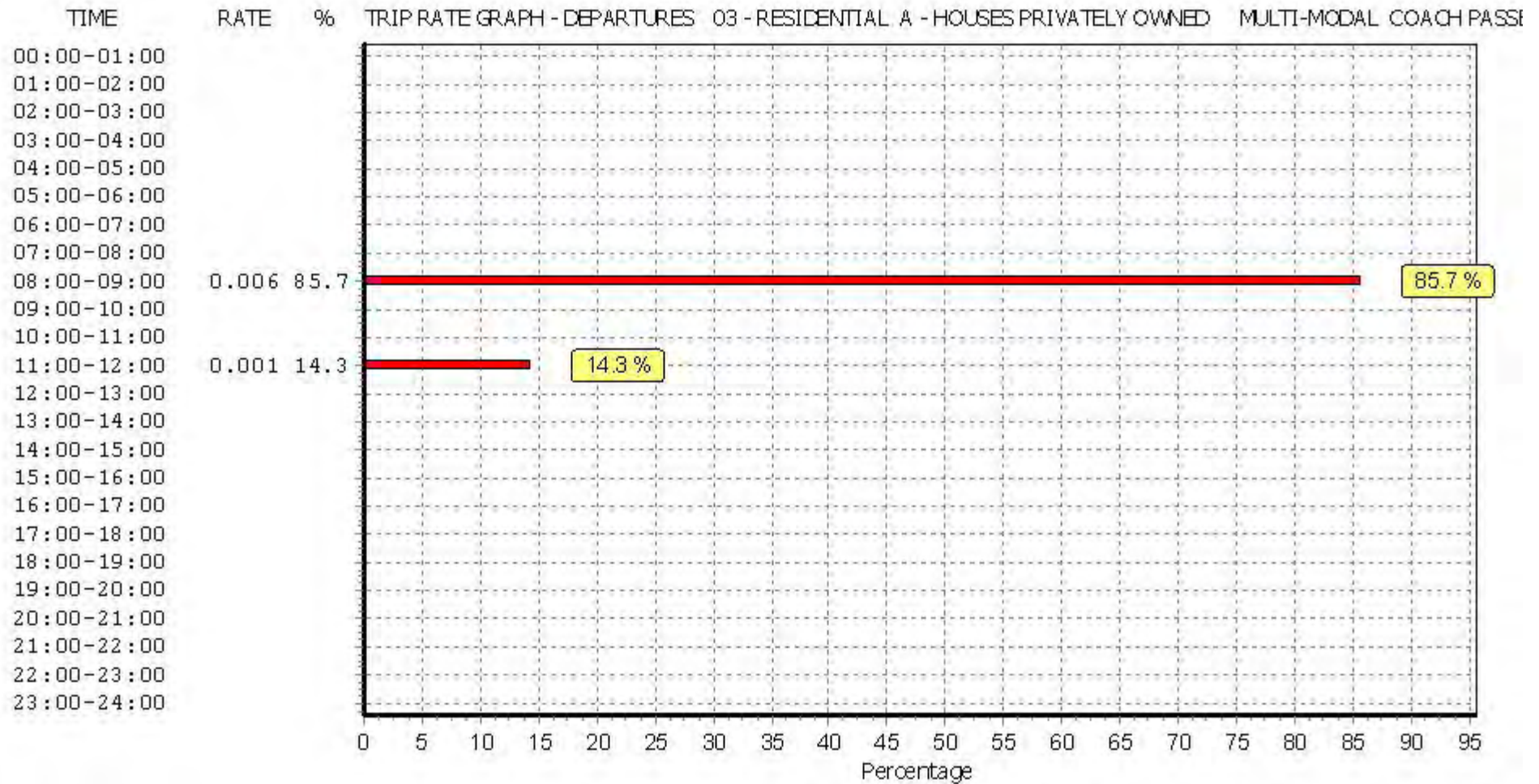

This graph is a visual representation of the trip rate calculation results screen. The same time periods and trip rates are displayed, but in addition there is an additional column showing the percentage of the total trip rate by individual time period, allowing peak periods to be easily identified through observation. Note that the type of count and the selected direction is shown at the top of the graph.



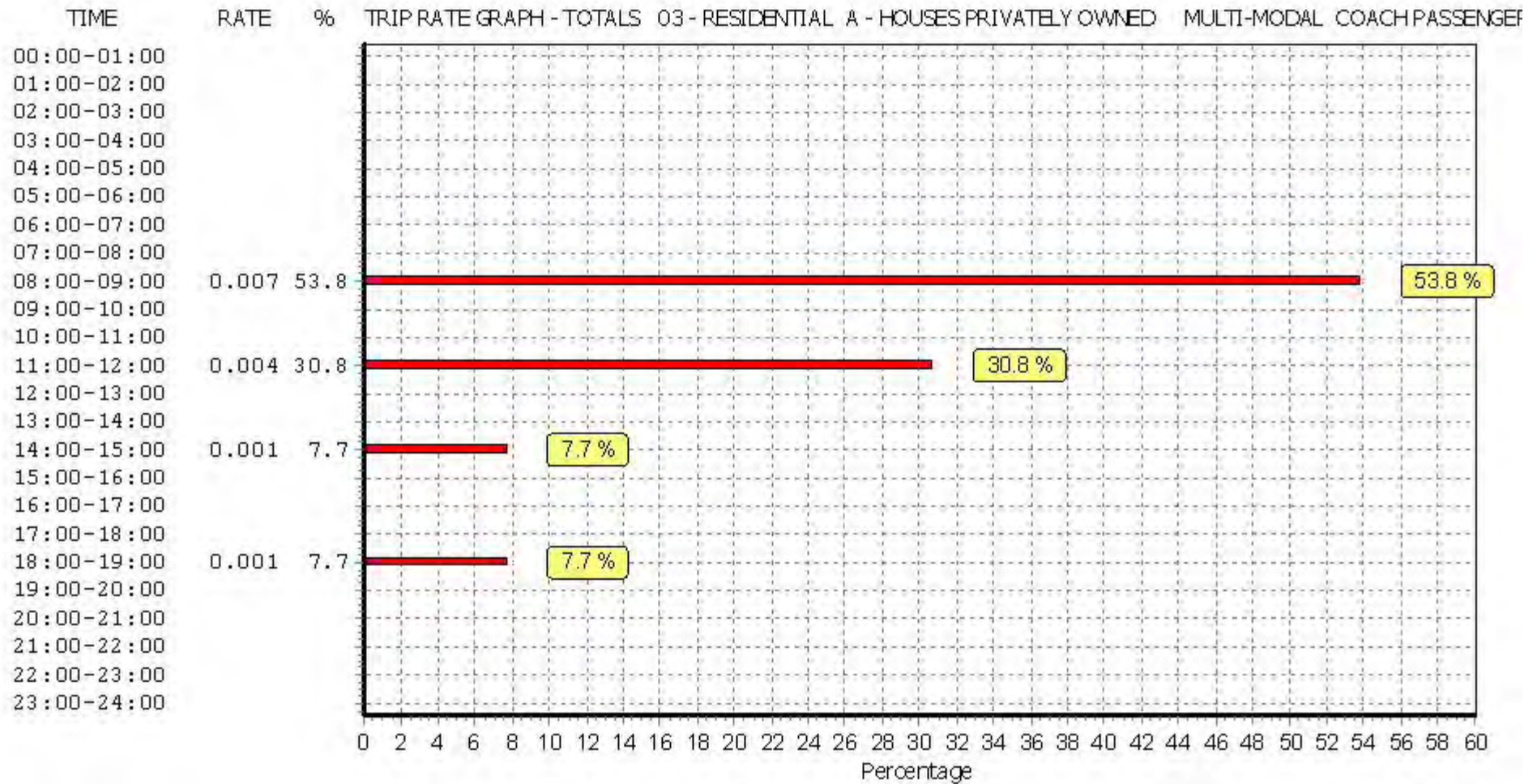

This graph is a visual representation of the trip rate calculation results screen. The same time periods and trip rates are displayed, but in addition there is an additional column showing the percentage of the total trip rate by individual time period, allowing peak periods to be easily identified through observation. Note that the type of count and the selected direction is shown at the top of the graph.

TRIP RATE for Land Use 03 - RESIDENTIAL/A - HOUSES PRIVATELY OWNED  
 MULTI-MODAL PUBLIC TRANSPORT USERS  
 Calculation factor: 1 DWELLS  
 BOLD print indicates peak (busiest) period

Time Range	ARRIVALS			DEPARTURES			TOTALS		
	No. Days	Ave. DWELLS	Trip Rate	No. Days	Ave. DWELLS	Trip Rate	No. Days	Ave. DWELLS	Trip Rate
00:00 - 01:00									
01:00 - 02:00									
02:00 - 03:00									
03:00 - 04:00									
04:00 - 05:00									
05:00 - 06:00									
06:00 - 07:00									
07:00 - 08:00	8	173	0.000	8	173	0.004	8	173	0.004
08:00 - 09:00	8	173	0.001	8	173	0.012	8	173	0.013
09:00 - 10:00	8	173	0.001	8	173	0.007	8	173	0.008
10:00 - 11:00	8	173	0.003	8	173	0.002	8	173	0.005
11:00 - 12:00	8	173	0.007	8	173	0.005	8	173	0.012
12:00 - 13:00	8	173	0.004	8	173	0.004	8	173	0.008
13:00 - 14:00	8	173	0.007	8	173	0.003	8	173	0.010
14:00 - 15:00	8	173	0.003	8	173	0.003	8	173	0.006
15:00 - 16:00	8	173	0.007	8	173	0.001	8	173	0.008
16:00 - 17:00	8	173	0.004	8	173	0.001	8	173	0.005
17:00 - 18:00	8	173	0.004	8	173	0.001	8	173	0.005
18:00 - 19:00	8	173	0.006	8	173	0.000	8	173	0.006
19:00 - 20:00									
20:00 - 21:00									
21:00 - 22:00									
22:00 - 23:00									
23:00 - 24:00									
<b>Total Rates:</b>			0.047			0.043			0.090

This section displays the trip rate results based on the selected set of surveys and the selected count type (shown just above the table). It is split by three main columns, representing arrivals trips, departures trips, and total trips (arrivals plus departures). Within each of these main columns are three sub-columns. These display the number of survey days where count data is included (per time period), the average value of the selected trip rate calculation parameter (per time period), and the trip rate result (per time period). Total trip rates (the sum of the column) are also displayed at the foot of the table.

To obtain a trip rate, the average (mean) trip rate parameter value (TRP) is first calculated for all selected survey days that have count data available for the stated time period. The average (mean) number of arrivals, departures or totals (whichever applies) is also calculated (COUNT) for all selected survey days that have count data available for the stated time period. Then, the average count is divided by the average trip rate parameter value, and multiplied by the stated calculation factor (shown just above the table and abbreviated here as FACT). So, the method is: COUNT/TRP\*FACT. Trip rates are then rounded to 3 decimal places.

Parameter summary

Trip rate parameter range selected: 101 - 432 (units: )  
 Survey date date range: 01/01/06 - 20/05/15  
 Number of weekdays (Monday-Friday): 8  
 Number of Saturdays: 0  
 Number of Sundays: 0  
 Surveys automatically removed from selection: 0  
 Surveys manually removed from selection: 1

This section displays a quick summary of some of the data filtering selections made by the TRICS® user. The trip rate calculation parameter range of all selected surveys is displayed first, followed by the range of minimum and maximum survey dates selected by the user. Then, the total number of selected weekdays and weekend days in the selected set of surveys are show. Finally, the number of survey days that have been manually removed from the selected set outside of the standard filtering procedure are displayed.

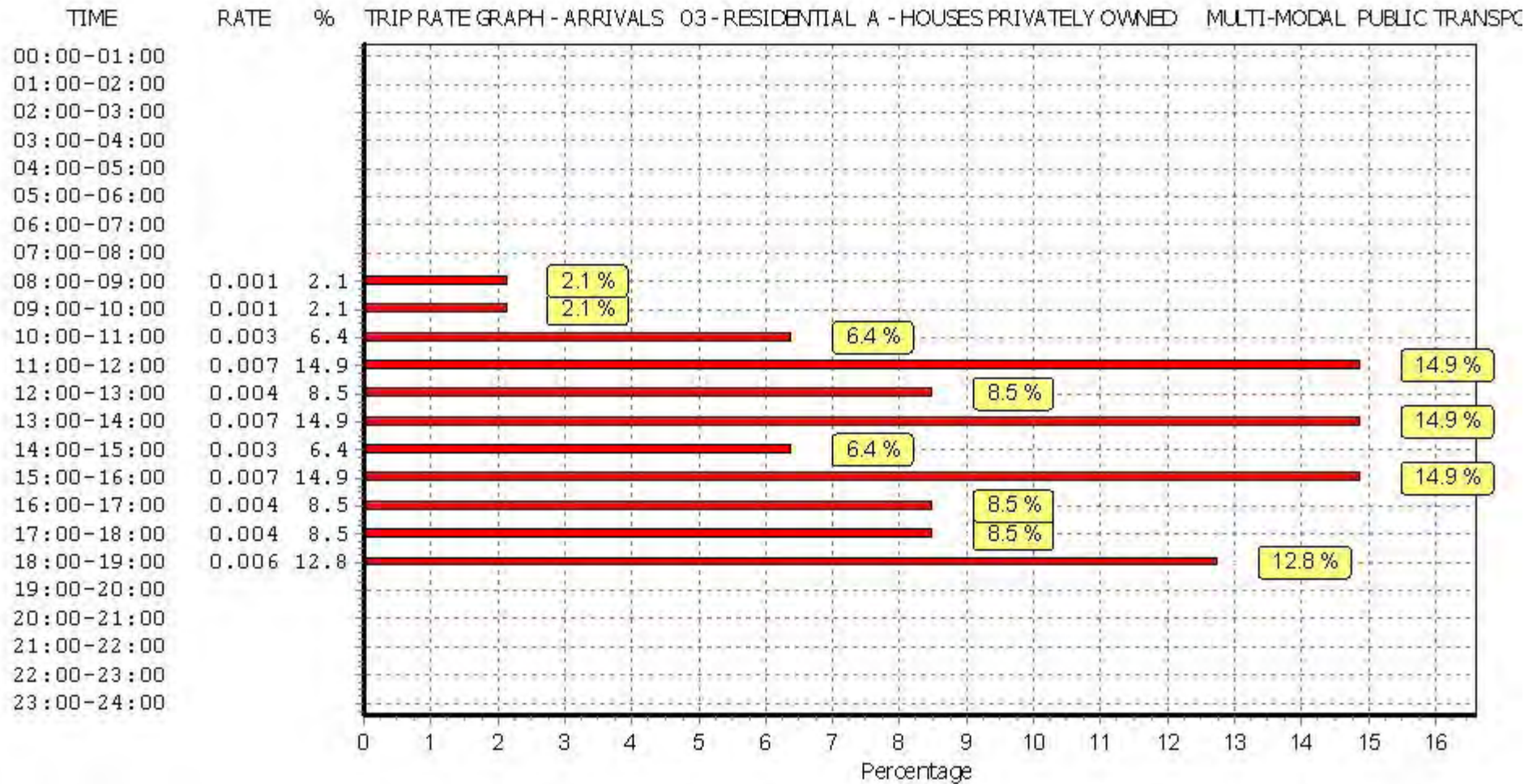

This graph is a visual representation of the trip rate calculation results screen. The same time periods and trip rates are displayed, but in addition there is an additional column showing the percentage of the total trip rate by individual time period, allowing peak periods to be easily identified through observation. Note that the type of count and the selected direction is shown at the top of the graph.



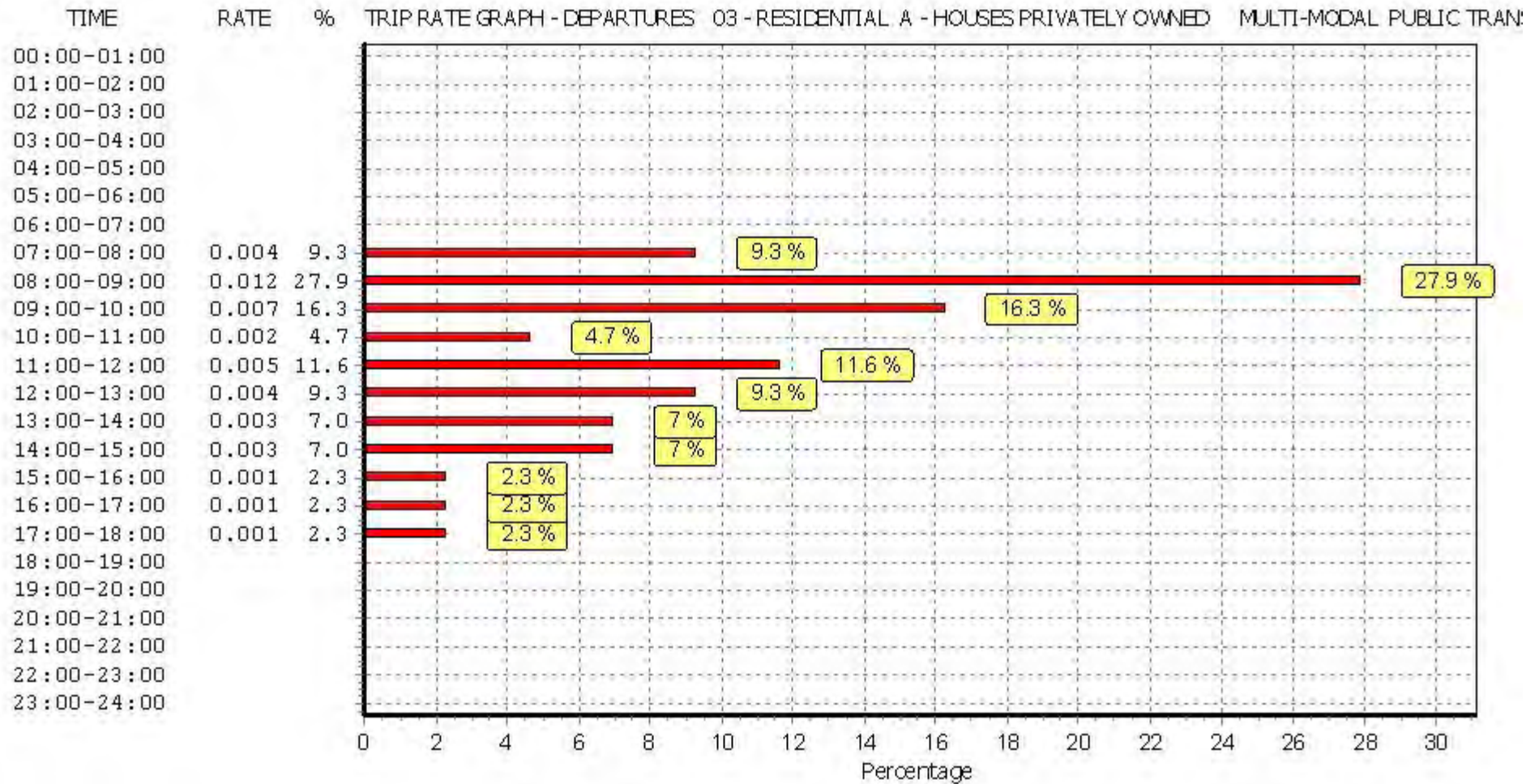

This graph is a visual representation of the trip rate calculation results screen. The same time periods and trip rates are displayed, but in addition there is an additional column showing the percentage of the total trip rate by individual time period, allowing peak periods to be easily identified through observation. Note that the type of count and the selected direction is shown at the top of the graph.



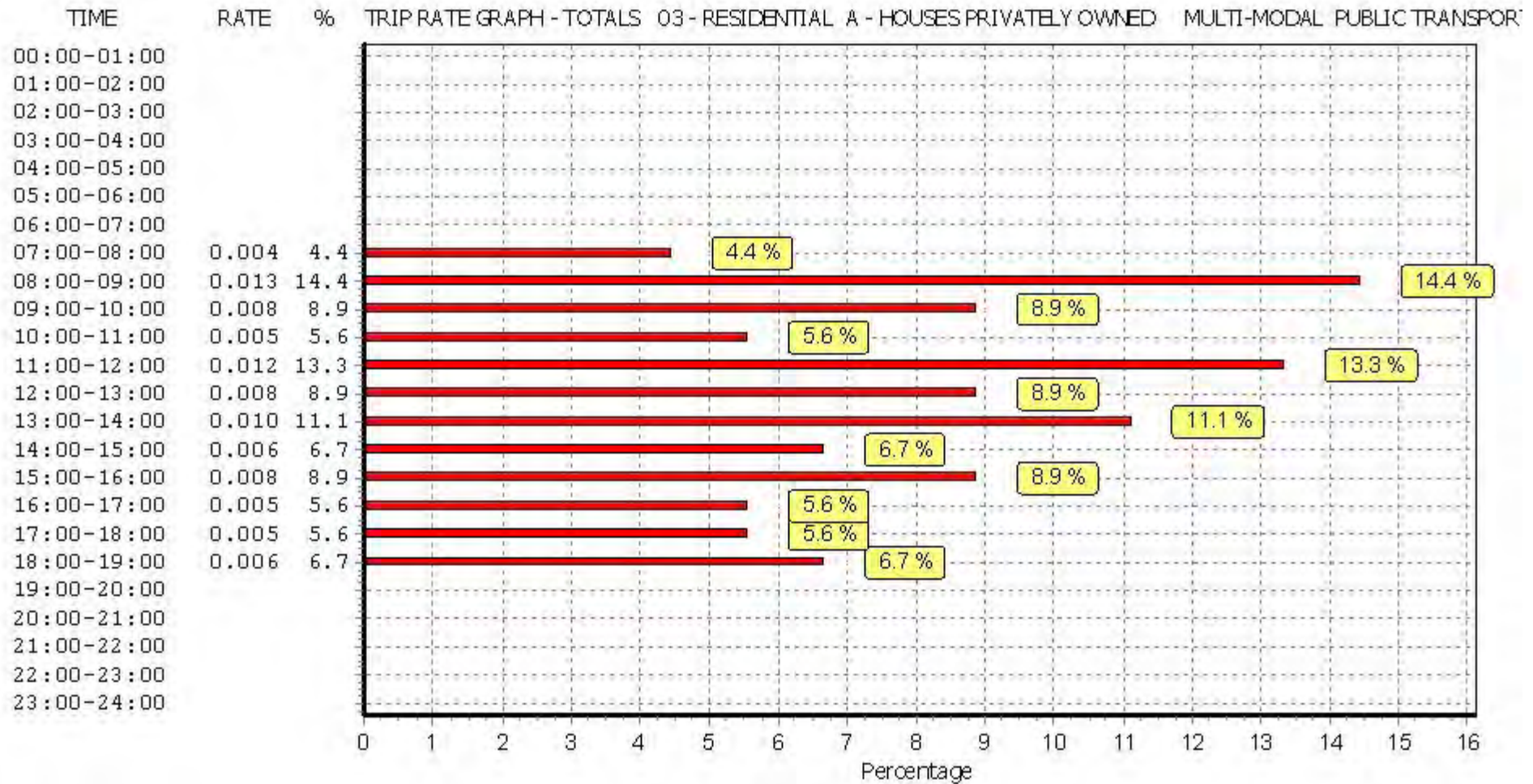

This graph is a visual representation of the trip rate calculation results screen. The same time periods and trip rates are displayed, but in addition there is an additional column showing the percentage of the total trip rate by individual time period, allowing peak periods to be easily identified through observation. Note that the type of count and the selected direction is shown at the top of the graph.

TRIP RATE for Land Use 03 - RESIDENTIAL/A - HOUSES PRIVATELY OWNED  
 MULTI-MODAL TOTAL PEOPLE  
 Calculation factor: 1 DWELLS  
 BOLD print indicates peak (busiest) period

Time Range	ARRIVALS			DEPARTURES			TOTALS		
	No. Days	Ave. DWELLS	Trip Rate	No. Days	Ave. DWELLS	Trip Rate	No. Days	Ave. DWELLS	Trip Rate
00:00 - 01:00									
01:00 - 02:00									
02:00 - 03:00									
03:00 - 04:00									
04:00 - 05:00									
05:00 - 06:00									
06:00 - 07:00									
07:00 - 08:00	8	173	0.114	8	173	0.359	8	173	0.473
08:00 - 09:00	8	173	0.184	8	173	0.753	8	173	0.937
09:00 - 10:00	8	173	0.234	8	173	0.317	8	173	0.551
10:00 - 11:00	8	173	0.219	8	173	0.278	8	173	0.497
11:00 - 12:00	8	173	0.228	8	173	0.210	8	173	0.438
12:00 - 13:00	8	173	0.271	8	173	0.265	8	173	0.536
13:00 - 14:00	8	173	0.242	8	173	0.260	8	173	0.502
14:00 - 15:00	8	173	0.277	8	173	0.307	8	173	0.584
15:00 - 16:00	8	173	0.539	8	173	0.320	8	173	0.859
16:00 - 17:00	8	173	0.568	8	173	0.304	8	173	0.872
17:00 - 18:00	8	173	0.519	8	173	0.338	8	173	0.857
18:00 - 19:00	8	173	0.383	8	173	0.354	8	173	0.737
19:00 - 20:00									
20:00 - 21:00									
21:00 - 22:00									
22:00 - 23:00									
23:00 - 24:00									
<b>Total Rates:</b>			<b>3.778</b>			<b>4.065</b>			<b>7.843</b>

This section displays the trip rate results based on the selected set of surveys and the selected count type (shown just above the table). It is split by three main columns, representing arrivals trips, departures trips, and total trips (arrivals plus departures). Within each of these main columns are three sub-columns. These display the number of survey days where count data is included (per time period), the average value of the selected trip rate calculation parameter (per time period), and the trip rate result (per time period). Total trip rates (the sum of the column) are also displayed at the foot of the table.

To obtain a trip rate, the average (mean) trip rate parameter value (TRP) is first calculated for all selected survey days that have count data available for the stated time period. The average (mean) number of arrivals, departures or totals (whichever applies) is also calculated (COUNT) for all selected survey days that have count data available for the stated time period. Then, the average count is divided by the average trip rate parameter value, and multiplied by the stated calculation factor (shown just above the table and abbreviated here as FACT). So, the method is: COUNT/TRP\*FACT. Trip rates are then rounded to 3 decimal places.

Parameter summary

Trip rate parameter range selected: 101 - 432 (units: )  
 Survey date date range: 01/01/06 - 20/05/15  
 Number of weekdays (Monday-Friday): 8  
 Number of Saturdays: 0  
 Number of Sundays: 0  
 Surveys automatically removed from selection: 0  
 Surveys manually removed from selection: 1

This section displays a quick summary of some of the data filtering selections made by the TRICS® user. The trip rate calculation parameter range of all selected surveys is displayed first, followed by the range of minimum and maximum survey dates selected by the user. Then, the total number of selected weekdays and weekend days in the selected set of surveys are show. Finally, the number of survey days that have been manually removed from the selected set outside of the standard filtering procedure are displayed.

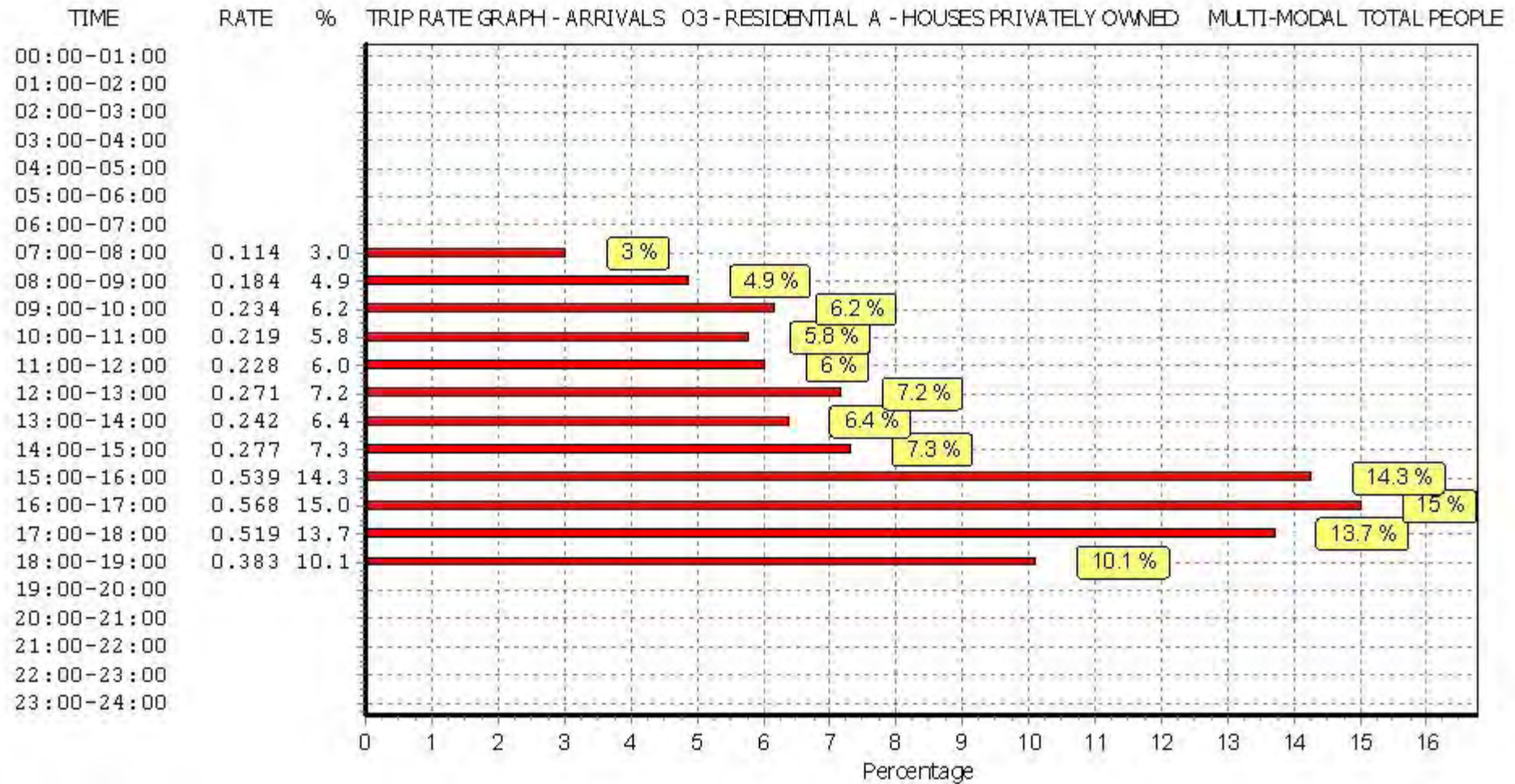

This graph is a visual representation of the trip rate calculation results screen. The same time periods and trip rates are displayed, but in addition there is an additional column showing the percentage of the total trip rate by individual time period, allowing peak periods to be easily identified through observation. Note that the type of count and the selected direction is shown at the top of the graph.



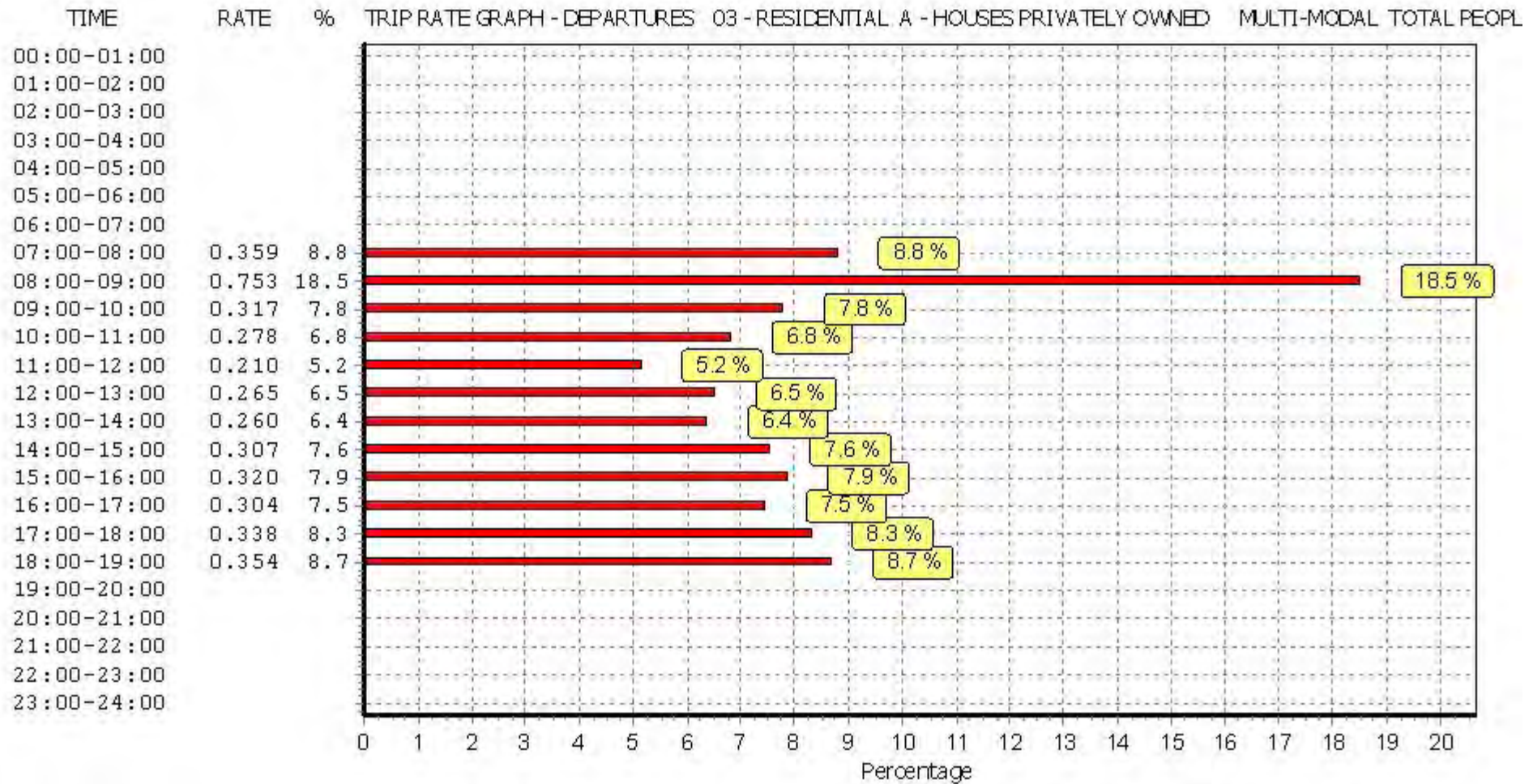

This graph is a visual representation of the trip rate calculation results screen. The same time periods and trip rates are displayed, but in addition there is an additional column showing the percentage of the total trip rate by individual time period, allowing peak periods to be easily identified through observation. Note that the type of count and the selected direction is shown at the top of the graph.



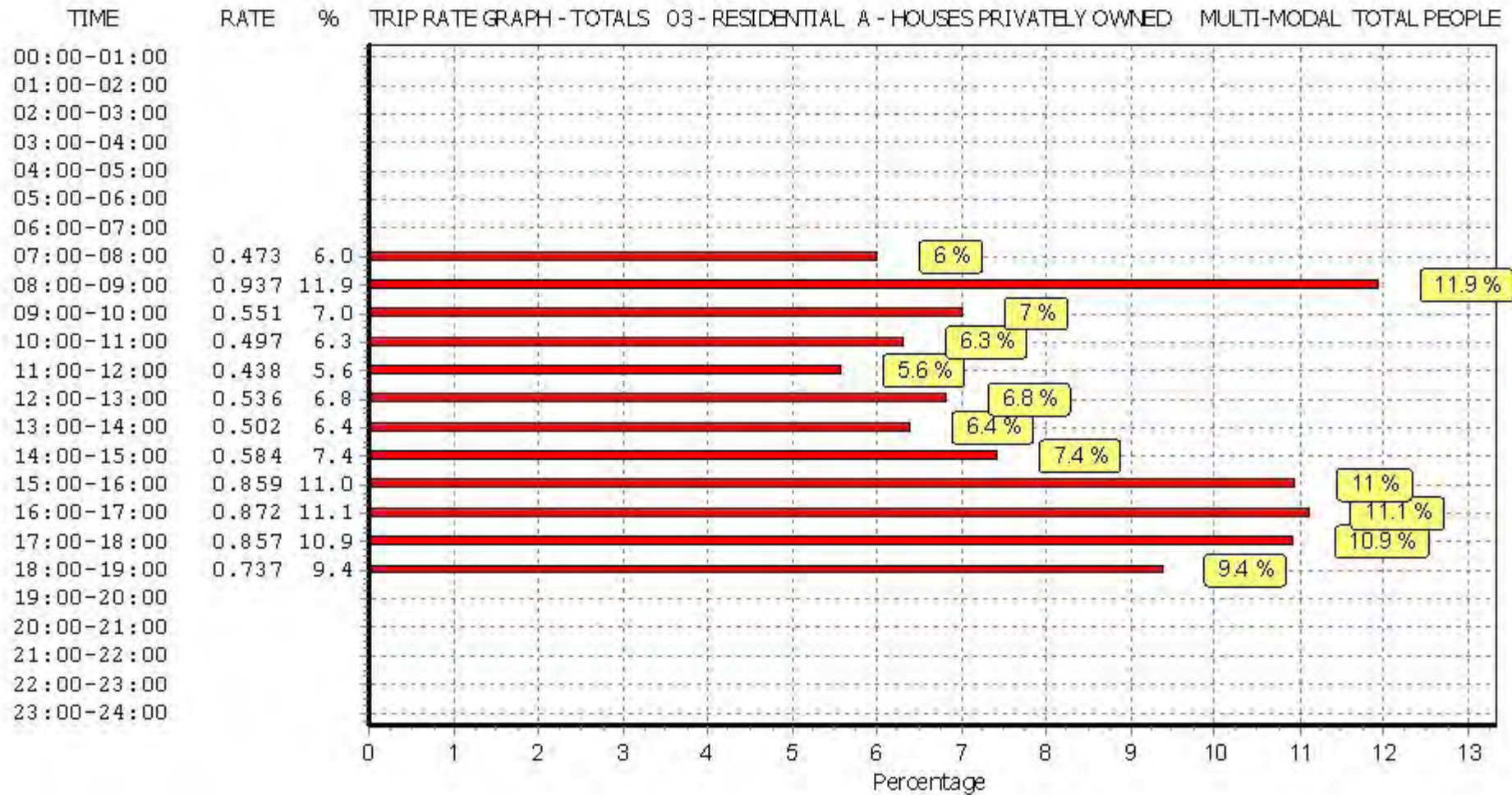

This graph is a visual representation of the trip rate calculation results screen. The same time periods and trip rates are displayed, but in addition there is an additional column showing the percentage of the total trip rate by individual time period, allowing peak periods to be easily identified through observation. Note that the type of count and the selected direction is shown at the top of the graph.

# **APPENDIX F**

## **Convergence Statistics**

**Table A.E.1 – 2031 IP SC0 Convergence Statistics**

AM Peak			Inter Peak			PM Peak		
Iteration	Delta (δ)	% Flow	Iteration	Delta (δ)	% Flow	Iteration	Delta (δ)	% Flow
			1	0.056	-			
			2	0.00000	95.7			
			3	0.00000	100.0			
			4	0.00000	100.0			
			5	0.00000	100.0			
			6	0.00000	100.0			

**Table A.E.2 – 2031 IP SC1 Convergence Statistics**

AM Peak			Inter Peak			PM Peak		
Iteration	Delta (δ)	% Flow	Iteration	Delta (δ)	% Flow	Iteration	Delta (δ)	% Flow
			1	0.053	-			
			2	0.00000	88.4			
			3	0.00000	100.0			
			4	0.00000	100.0			
			5	0.00000	100.0			
			6	0.00000	100.0			

**Table A.E.3 – 2031 IP SC2 Convergence Statistics**

AM Peak			Inter Peak			PM Peak		
Iteration	Delta (δ)	% Flow	Iteration	Delta (δ)	% Flow	Iteration	Delta (δ)	% Flow
			1	0.050	-			
			2	0.00000	87.7			
			3	0.00000	100.0			
			4	0.00000	100.0			
			5	0.00000	100.0			
			6	0.00000	100.0			

**Table A.E.4 – 2031 IP SC3 Convergence Statistics**

AM Peak			Inter Peak			PM Peak		
Iteration	Delta (δ)	% Flow	Iteration	Delta (δ)	% Flow	Iteration	Delta (δ)	% Flow
			1	0.048	-			
			2	0.00000	87.7			
			3	0.00000	100.0			
			4	0.00000	100.0			
			5	0.00000	100.0			
			6	0.00000	100.0			

**Table A.E.5– 2031 IP SC4 Convergence Statistics**

AM Peak			Inter Peak			PM Peak		
Iteration	Delta (δ)	% Flow	Iteration	Delta (δ)	% Flow	Iteration	Delta (δ)	% Flow
			1	0.046	-			
			2	0.00000	87.0			
			3	0.00000	100.0			
			4	0.00000	100.0			
			5	0.00000	100.0			
			6	0.00000	100.0			

**Table A.E.6 – 2031 IP SC5 Convergence Statistics**

AM Peak			Inter Peak			PM Peak		
Iteration	Delta (δ)	% Flow	Iteration	Delta (δ)	% Flow	Iteration	Delta (δ)	% Flow
			1	0.045	-			
			2	0.00000	86.6			
			3	0.00000	100.0			
			4	0.00000	100.0			
			5	0.00000	100.0			
			6	0.00000	100.0			